



# KIMEP FACT BOOK

Volume 3

*Fall 2008*



DEPARTMENT OF QUALITY ASSURANCE AND  
INSTITUTIONAL RESEARCH

ALMATY 2008

## TABLE OF CONTENTS

Foreword by President of KIMEP.....	4
Foreword by Executive Vice President of KIMEP.....	5
Note from QAIR team.....	6
KIMEP at a Glance.....	7
Organizational Structure.....	8
Campus map.....	9
Students' geography.....	10
Faculty members' geography.....	10
STUDENT BODY STATISTICS.....	11
<i>Admission Statistics</i> .....	11
Admission Statistics, Fall 2006.....	11
Admission Statistics, Fall 2007.....	11
Total Numbers of Applied and Accepted in Fall 2007 by Colleges and Centers, <i>Graph</i> .....	11
<i>Enrollment Statistics</i> .....	12
Freshman Enrollment, 2005-08.....	12
Number of Enrolled students, 2005-08.....	12
Total number of enrolled students, 2005-08, <i>Graph</i> .....	12
Average Age of Enrolled Students, 2005-08.....	13
Average Age of Enrolled Students by Degree Level, 2005-08, <i>Graph</i> .....	13
Enrolled Students by Gender, 2005-08.....	13
Average Grades of Enrolled Students.....	14
Number of Students, Eligible to Enroll, by Programs and Gender.....	14
Percentage of Students, Eligible to Enroll, by Programs and Gender, 2007-08, <i>Graph</i> .....	14
Number of Students participating in KIMEP Exchange Programs, 2005-08.....	15
<i>Graduated Students Statistics</i> .....	15
Total Conferred Degrees, 2005-08.....	15
Conferred Degrees by Gender in numbers, 2005-08.....	15
Conferred Degrees by Gender in percentage, 2005-08, <i>Graph</i> .....	16
Average GPA at Graduation by Programs, 2005-08.....	16
Length of Study of Undergraduates, 2005-08.....	16
Length of Study of Graduates, 2005-08.....	17
<i>Student Organizations</i> .....	17
Number of KIMEP Student Organizations, 2005-08, <i>Graph</i> .....	17
KIMEP Speakers' Forum, 2005-08.....	17
Presidents of KIMEP Student Government, 2005-08.....	17
Student Organizations' List and Scope of Activity, 2005-08.....	18
FACULTY BODY STATISTICS.....	19
<i>Number and Scope</i> .....	19
Dynamics of Faculty Members Headcount, 2005-08, <i>Graph</i> .....	19
Faculty Members Composition by Degree, 2005-08.....	19
Full Time and Part Time Faculty Members at Colleges and Centers, 2005-08.....	20
Faculty Members' Countries of Origin, 2006-08.....	20
<i>Professional development</i> .....	20
KIMEP Faculty Members Studying at KIMEP.....	20
KIMEP Faculty Members Studying Abroad, 2005-06.....	21
KIMEP Faculty Members Studying Abroad, 2006-07.....	21
KIMEP Faculty Members Studying Abroad, 2007-08.....	21
<i>Research activity by departments, 2005-2008 AYs</i> .....	22
KIMEP Grants Awarded, numbers.....	22
KIMEP Grants Awarded, cost, USD.....	22
Non-KIMEP Grants Awarded, numbers.....	22
Non-KIMEP Grants Awarded, cost, USD.....	23
Consulting Contracts Carried out, numbers.....	23

Conferences Attended, numbers .....	23
Publications, numbers.....	23
ALUMNI.....	24
<i>Number and Scope</i> .....	24
Total Number of KIMEP Alumni, 1994-08, <i>Graph</i> .....	24
Number of Alumni by Program, 1994-08 .....	24
Number of Alumni Employed or Further Studying, 2003-07 .....	24
<i>Employment and Salary</i> .....	25
Factors assisting in getting first job after graduating from KIMEP, 2005, <i>Graph</i> .....	25
Factors assisting in getting first job after graduating from KIMEP, 2006, <i>Graph</i> .....	25
Fields of Alumni's Employment, 2005-07 .....	25
Salary Level of KIMEP Alumni 2005, <i>Graph</i> .....	26
Salary Level of KIMEP Alumni 2006, <i>Graph</i> .....	26
Salary Level of KIMEP Alumni 2007, <i>Graph</i> .....	26
<i>Success Stories of KIMEP Alumni</i> .....	27
Gulnara Akhmetova, MBA-1997.....	27
Yevgeniy Kopaigora, MBA-1998.....	27
Aidar Utkelov, MPA-1998 .....	27
Dilbar Gimranova, MBA-2000 .....	27
Arman Zholdasbekov, MBA-2001 .....	28
Didar Zhumagulov, MBA-2003.....	28
Aida Sapargazinova, Ex MBA-2004.....	28
Gulmara Rysbekova, BSc-2006, MBA-2007 .....	28
ACADEMIC PROGRAMS AND SPECIALIZATIONS .....	29
Graduate Programs, 2005-09.....	29
Undergraduate Programs, 2005-09.....	30
Number of Specializations: Bachelor, Master and Doctoral Programs, 2005-09, <i>Graph</i> .....	30
FINANCIAL AID AND FEES.....	31
<i>Financial Aid</i> .....	31
Corporate-Funded Financial Aid, 2005-08.....	31
KIMEP-Funded Financial Aid, 2005-08 .....	32
<i>Tuition</i> .....	33
Tuition, 2005-09 .....	33
<i>Fees</i> .....	34
Some Other Fees, 2005-09.....	34
Student Dormitory Fees, 2005-09 .....	34
Services Fees, 2007-09 .....	34
CAMPUS AND FACILITIES.....	35
Library Holdings and Space, 2005-08 .....	35
Computer Facilities, 2005-09.....	35
Dynamics of KIMEP Computer Facilities, 2005-09, <i>Graph</i> .....	36
KIMEP Teaching Aid Facilities, Spring 2008.....	36
Campus Technical Characteristics, Spring 2007, Spring 2008 .....	36
UNIVERSITY FINANCES .....	37
KIMEP Budget, 2007-08 .....	37
KIMEP Budget, 2005-08 .....	38
KIMEP Budget Dynamics, 2005-08, <i>Graph</i> .....	38
ADMINISTRATIVE STAFF .....	39
<i>Number and Scope</i> .....	39
Staff Headcount, Fall 2007 .....	39
<i>Professional development</i> .....	40
Support Staff Studying Abroad, 2007-08.....	40
Support Staff Studying at KIMEP, 2005-08 .....	40
Staff Participation in Professional Trainings at College of Continuing Education, 2006-08.....	40
Key Contact Details.....	41



*Dr. Chan Young Bang,  
President of KIMEP*

## **FOREWORD**

The Kazakhstan Institute of Management, Economics and Strategic Research (KIMEP) is a non-profit institution of higher education. Its mission is to develop well-educated citizens and to improve the quality of life in the country and the region through the provision of teaching, learning, research, and community service, which foster excellence in scholarship, innovation and social responsibility.

KIMEP is a prominent Western-style University in the Commonwealth of Independent States (CIS) offering North American credit based graduate and undergraduate degrees in a wide variety of disciplines in Arts, Social Sciences and Business Administration that are comparable with international norms and standards.

Therefore, it is my pleasure to present KIMEP Fact Book. This publication is designed to provide every interested person with reliable information on our University.

I believe the information provided will give all potential students and collaborators a comprehensive picture of the vibrant and multifaceted nature of this institution.

Chan Young Bang, Ph.D.  
President of KIMEP



*M.H. Rahman, Ph.D.  
Executive Vice President of KIMEP*

## **FOREWORD**

It is my pleasure to present to you the new volume of KIMEP Fact Book that provides information for the last three academic years, reflecting the Institute's endeavors in achieving international accreditation as a higher educational institution.

This is the third edition of KIMEP Fact Book, and the time has come to shape the publication mainly as a statistical data source, allowing for greater clearness, simplicity and reader-friendliness. The publication also allows taking a glimpse of the everyday KIMEP life through pictures of our students, teachers and campus.

The Book is available for a wide range of readers and we hope that it will serve as an effective guide on KIMEP for our respected clients.

M. H. Rahman, Ph.D.  
Executive Vice President of KIMEP

*The third volume of KIMEP Fact Book provides all interested readers with brief statistical information about our Institute. The information contained in this volume mainly covers three academic years: 2005-06, 2006-07, and 2007-08.*

*QAIR team appreciates the input of all departments and units that presented information for this volume: Registrar's Office, Human Resources Department, Offices of the Executive Vice-President and Vice President for Academic Affairs, Bang College of Business, College of Social Science, College of Continuing Education, Administration and Finance Division, Department of Finance and Accounting, Career and Employment Center, Corporate Development Department, Computer and Information Systems Center, International Relations Office, Student Affairs Office, Library, Dormitory, and the Department of Marketing and Public Relations.*

*We express our special gratitude to KIMEP top management, who inspired and directed the creation and development of KIMEP Fact Book.*

# Part I. KIMEP at a Glance

## Established

January 1, 1992  
by resolution of the President of  
the Republic of Kazakhstan,  
Mr. Nursultan Nazarbayev

July 7, 2004  
Institute is reorganized into a  
nonprofit Joint Stock Company

## Motto

**Education to Change  
Society**

## School Color



## Mascot



## KIMEP Logo



## COLLEGES AND DEPARTMENTS

### Bang College of Business (BCB)

- Accounting
- Finance
- Management and Marketing
- Operations Management and Information Systems

### College of Social Sciences (CSS)

- Economics
- Political Science
- Public Administration
- Journalism and Mass Communications

### College of Continuing Education (CCE)

- Professional Development Program
- Open Enrollment and Certificate Program
- Distance Learning Program
- Pre-Degree Program

### Language Center (LC)

- English Section
- Kazakh Section
- Korean Section
- World Languages Program
- Foreign Languages Program

### Computer and Information Systems Center (CISC)

## STUDENTS

### Headcount of Enrolled Students by Semesters, 2005-08

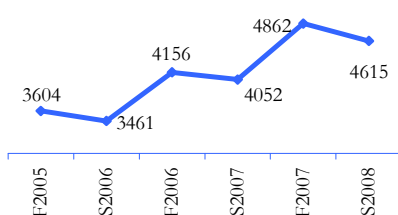

### Enrolled Students

	F2007	S2008
<b>Bachelors</b>	4357	4147
<i>average age</i>	20	20
<b>Masters</b>	495	458
<i>average age</i>	28	28
<b>DBA</b>	10	10
<i>average age</i>	38	38
<b>TOTAL</b>	<b>4862</b>	<b>4615</b>

### Alumni Headcount

*As of Spring 2008*  
4,490

## Faculty Headcount -

*As of Fall 2007*

### Bang College of Business

Full Time 52  
Part Time 8

### College of Social Sciences

Full Time 60  
Part Time 26

### Language Center

Full Time 79  
Part Time 35

### Computer and Information Systems Center

Full Time 6

## SUPPORT STAFF

### Support Staff Headcount

*As of Fall 2007*

	Management	Subordinates	Total
<b>Total</b>	<b>92</b>	<b>432</b>	<b>524</b>
<b>Administration and Finance</b>	27	286	313
<b>Academic Affairs</b>	44	108	152
<b>Student Affairs</b>	7	16	23
<b>President's Office</b>	10	15	25
<b>Advancement</b>	4	7	11

## PROGRAMS AND SPECIALIZATIONS

### 19 Undergraduate Specializations

#### Bachelor of Science in Business Administration and Accounting (BSc)

Majors: Accounting; Finance; Marketing; Management; Operations Management; Information Systems (6)

#### Bachelor of Arts in Economics (BAE)

Majors: Public Policy Economics; Business Economics (2)

#### Bachelor of Social Science (BSS)

Majors: Public Policy and Administration; Public Management, Financial Management, Natural Resources Management, Central Asian Politics; Comparative Politics, Foreign Policy and Diplomacy, International Security (8)

#### Bachelor of Arts in International Journalism (BAIJ)

Major: Media Management; Print, Broadcast and Online Journalism; Public Relations (3)

## 23 Graduate Specializations

### 18 Master Specializations

#### Master of Business Administration (MBA)

Majors: Accounting; Finance; Marketing; Management; Operations Management; Information Systems (6)

#### Executive Master of Business Administration (ExMBA)

#### Master of Arts in Economics (MA)

Majors: International Economics; Public Policy Economics; Financial Economics (3)

#### Master in International Relations (MIR)

#### Master in Public Administration (MPA)

Majors: Financial Management; Public Policy; Public Management (3)

#### Master of Arts in International Journalism (MAIJ)

Majors: Public Relations; Print and Broadcast Journalism (2)

#### Master of Arts in Teaching English to Speakers of Other Languages (MA in TESOL)

#### Master of Law in International Business Law

### 5 Doctoral Specializations

#### Doctor of Business Administration (DBA)

Majors: Accounting; Finance; Management; Marketing; Operations Management and Information Systems (5)

## 13 Certificate Programs (CCE)

## UNIVERSITY FINANCES

### Budget

*Academic year 2007-08*

USD 24.5 million (KZT 3,032 million)

*Academic year 2006-07*

USD 18.9 million (KZT 2,240 million)

*Academic year 2005-06*

USD 14.5 million (KZT 1,795 million)

### Tuition

*As of Fall 2008, KZT per one credit*

	Undergraduate	Graduate
<b>CIS</b>	16,600-	23,000-
<b>nationals</b>	22,650	131,440
<b>Non-CIS</b>	24,900-	34,660-
<b>nationals</b>	34,180	131,440

### Financial Aid

*As of Spring 2008*

KZT 58.303 thous. (funded by KIMEP)

KZT 57.516 thous. (externally funded)

# KIMEP ORGANIZATIONAL STRUCTURE

(as of June, 2008)

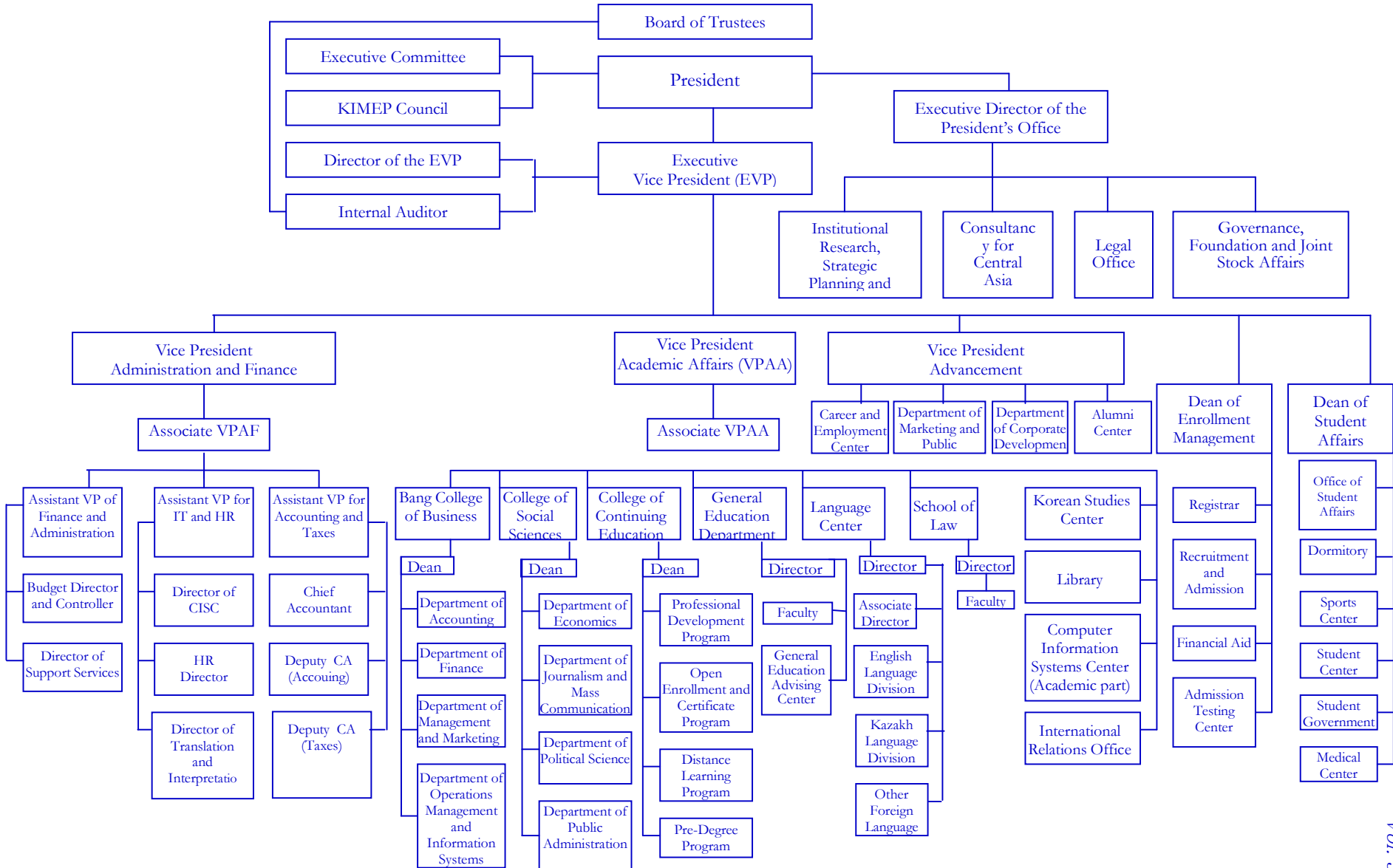



## CAMPUS MAP



- |                                  |  |
|----------------------------------|--|
| 1. Valikhanov Building           | 11. Publishing Department                        |
| 2. Lecture Halls 1,2             | 12. Parking Area                                 |
| 3. Great Hall                    | 13. Plant Department                             |
| 4. Student Center                | 14. Garage                                       |
| 5. Dostyk Building               | 15. Dormitory                                    |
| 6. Language Center, Sport Center | 16. College of Continuing Education              |
| 7. Apartment House               | 17. Registrar                                    |
| 8. Summer Sport Center           | 18. Medical Center, Consultancy for Central Asia |
| 9. New Academic Building         | 19. Admission                                    |
| 10. Library                      |  |

KIMEP Students Geography

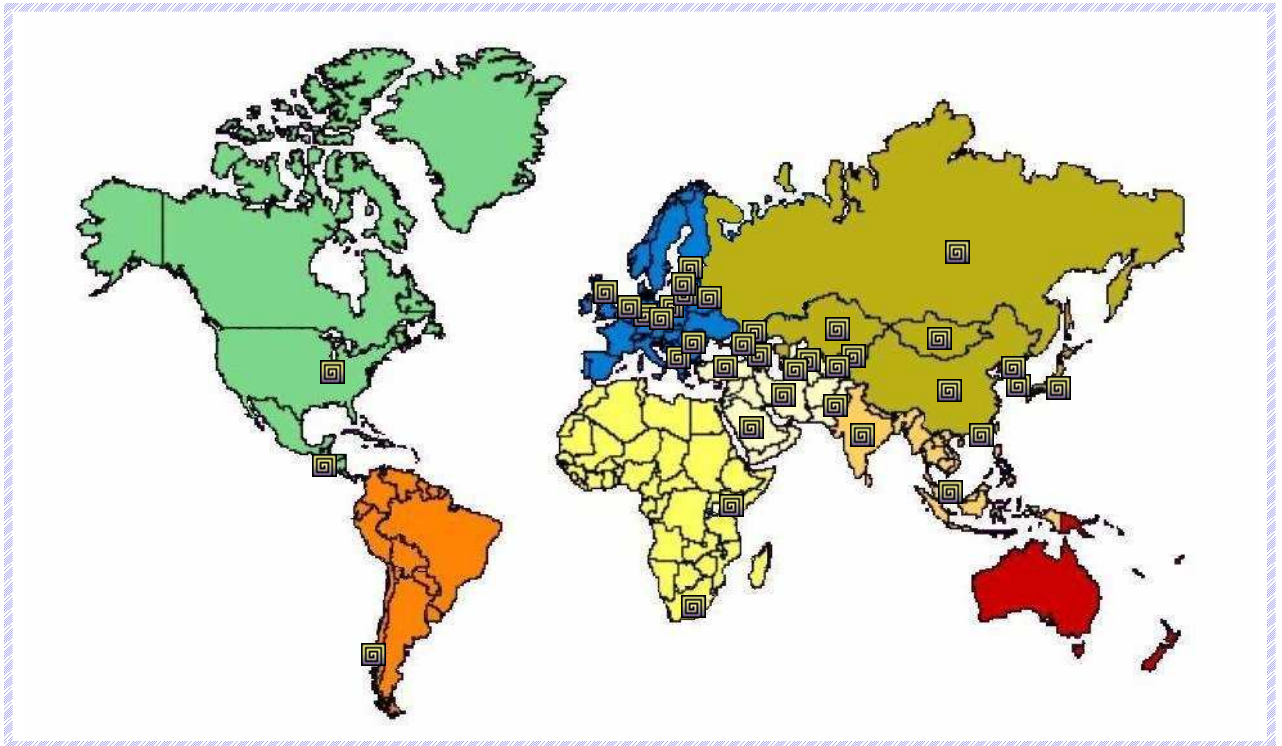

Countries: Armenia, Azerbaijan, Belarus, Chile, China, Czech Republic, Estonia, Georgia, Germany, Great Britain, Hong Kong, Japan, India, Iran, Kazakhstan, Kenya, Kyrgyzstan, Latvia, Lithuania, Malaysia, Mongolia, Netherlands, North Korea, Pakistan, Poland, Romania, Russia, Salvador, Saudi Arabia, South Africa, South Korea, Tajikistan, Turkey, Turkmenistan, USA, Uzbekistan, Yugoslavia

KIMEP Faculty Geography

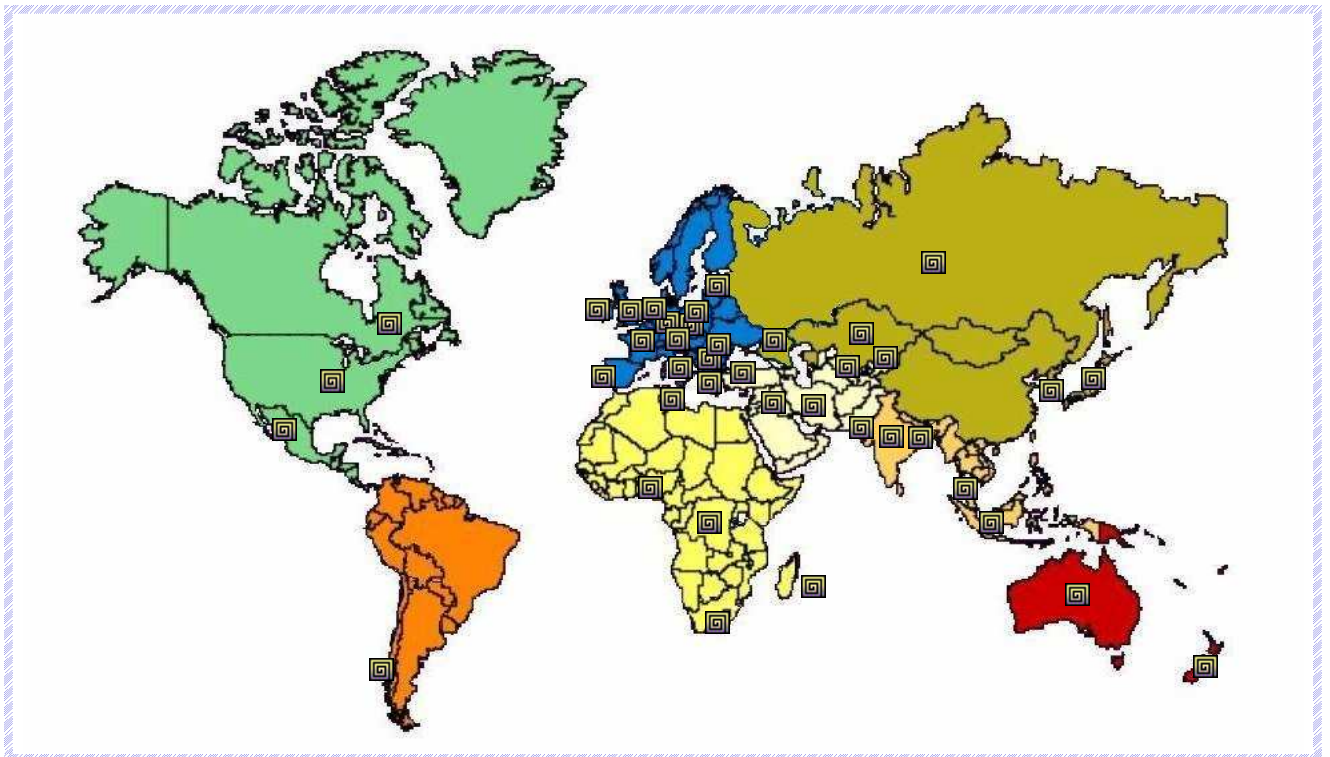

Countries: Armenia, Australia, Austria, Bangladesh, Canada, Chile, Congo, Czech Republic, France, Germany, Great Britain, Greece, India, Iran, Iraq, Ireland, Italy, Japan, Kazakhstan, Kyrgyzstan, Latvia, Malaysia, Mauritius, Mexico, Netherlands, New Zealand, Nigeria, Pakistan, Poland, Portugal, Romania, Russia, Singapore, South Africa, South Korea, Tunisia, Turkey, USA, Uzbekistan, Yugoslavia



## STUDENT BODY STATISTICS\*

### ADMISSION STATISTICS

#### Admission statistics

Fall 2006

Program	Undergraduate				Graduate					Total
	BAE	BAIJ	BSC	BSS	MA	MAIJ	MBA	MIR	MPA	
Number of applied										
December 2005 intake	9	3	47	41	0	0	12	0	0	112
I intake 2006	495	89	1 285	719	22	10	164	19	15	2 818
II intake 2006	371	78	877	567	55	19	138	8	31	2 144
<b>Total</b>	<b>875</b>	<b>170</b>	<b>2 209</b>	<b>1 327</b>	<b>77</b>	<b>29</b>	<b>314</b>	<b>27</b>	<b>46</b>	<b>5 074</b>
Status	BAE	BAIJ	BSC	BSS	MA	MAIJ	MBA	MIR	MPA	Total
Accepted	256	109	568	415	60	22	146	15	33	1 624
Provisional	131	22	263	192	0	2	19	1	3	633
<b>Total</b>	<b>387</b>	<b>131</b>	<b>831</b>	<b>607</b>	<b>60</b>	<b>24</b>	<b>165</b>	<b>16</b>	<b>36</b>	<b>2 257</b>

Fall 2007

Program	Undergraduate				Graduate						Total
	BAE	BAIJ	BSC	BSS	MA	MAIJ	MA TESOL	MBA	MIR	MPA	
Number of applied											
December 2006 Intake	14	4	93	46	2	2	0	45	1	3	210
I intake 2007	315	100	2 020	655	21	15	0	177	26	19	3 348
II intake 2007	298	39	1 422	532	24	16	18	215	9	14	2 587
III intake 2007	62	15	409	149	8	8	0	106	3	12	772
<b>Total</b>	<b>689</b>	<b>158</b>	<b>3 944</b>	<b>1 382</b>	<b>55</b>	<b>41</b>	<b>18</b>	<b>543</b>	<b>39</b>	<b>48</b>	<b>6 917</b>
Status	BAE	BAIJ	BSC	BSS	MA	MAIJ	MA TESOL	MBA	MIR	MPA	Total
Accepted	288	101	835	625	52	21	16	202	26	38	2204
Provisional	74	32	239	185	1	7	1	30			569
<b>Total</b>	<b>362</b>	<b>133</b>	<b>1074</b>	<b>810</b>	<b>53</b>	<b>28</b>	<b>17</b>	<b>232</b>	<b>26</b>	<b>38</b>	<b>2773</b>

#### Total Numbers of Applied and Accepted in Fall 2007 by Colleges and Centers\*\*

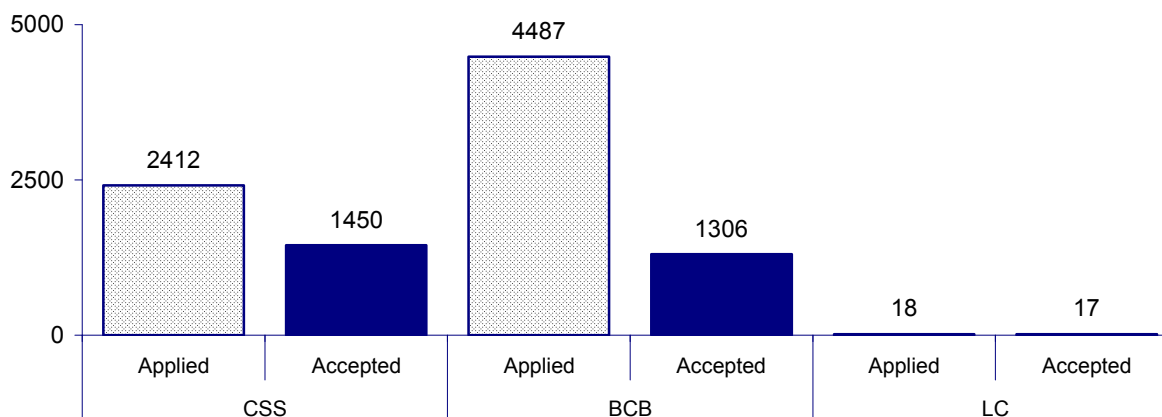

\* Data was provided by Office of the Registrar, Office of International Relations and Office of Dean of Student Affairs

\*\* Student Statistics for Fall 2008 will be prepared by Office of the Registrar in December 2008

**ENROLLMENT STATISTICS****Freshman Enrollment, 2005-08***Undergraduate*

Program	2005-2006			2006-2007			2007-2008		
	Regular	Provisional	Total	Regular	Provisional	Total	Regular	Provisional	Total
BAE	164	158	322	167	56	223	194	18	212
BAIJ	34	13	47	55	11	66	56	9	65
BSc	379	34	413	381	117	498	540	47	587
BSS	234	50	284	248	73	321	367	52	419
<b>TOTAL</b>	<b>811</b>	<b>255</b>	<b>1066</b>	<b>851</b>	<b>257</b>	<b>1108</b>	<b>1157</b>	<b>126</b>	<b>1283</b>

*Graduate*

Program	2005-2006			2006-2007			2007-2008		
	Regular	Provisional	Total	Regular	Provisional	Total	Regular	Provisional	Total
MA	16	0	16	29	0	29	22	0	22
MAIJ	13	0	13	13	0	13	9	1	10
MATESOL	-	-	-	0	0	0	15	0	15
MBA	128	0	128	105	14	119	121	12	133
MIR	8	0	8	7	0	7	11	0	11
MPA	21	0	21	22	1	23	16	0	16
<b>TOTAL</b>	<b>186</b>	<b>0</b>	<b>186</b>	<b>176</b>	<b>15</b>	<b>191</b>	<b>194</b>	<b>13</b>	<b>207</b>

**Number of Enrolled Students, 2005-08***Undergraduate*

Program	2005-2006				2006-2007				2007-2008			
	Fall	Spring	SU1	SU2	Fall	Spring	SU1	SU2	Fall	Spring	SU1	SU2
BAE	689	647	465	172	753	699	463	335	763	706	424	194
BAIJ	94	97	71	13	149	151	105	77	198	184	105	58
BSc	1626	1614	1168	410	1925	1900	1423	936	2275	2194	1551	973
BSS	744	698	478	132	871	855	598	524	1121	1063	687	320
<b>TOTAL</b>	<b>3153</b>	<b>3056</b>	<b>2182</b>	<b>727</b>	<b>3698</b>	<b>3605</b>	<b>2589</b>	<b>1872</b>	<b>4357</b>	<b>4147</b>	<b>2767</b>	<b>1545</b>

*Graduate*

Program	2005-2006				2006-2007				2007-2008			
	Fall	Spring	SU1	SU2	Fall	Spring	SU1	SU2	Fall	Spring	SU1	SU2
MA	41	32	15	2	37	31	15	23	43	38	13	9
MAIJ	36	32	7	3	31	23	10	4	22	21	9	0
MATESOL	-	-	-	-	0	0	10	0	15	15	11	0
MBA	295	267	207	107	312	316	213	114	346	319	203	108
MIR	28	28	17	4	25	27	18	14	19	19	12	4
MPA	51	46	27	15	53	50	26	21	50	46	26	12
<b>TOTAL</b>	<b>451</b>	<b>405</b>	<b>273</b>	<b>131</b>	<b>458</b>	<b>447</b>	<b>292</b>	<b>176</b>	<b>495</b>	<b>458</b>	<b>274</b>	<b>133</b>

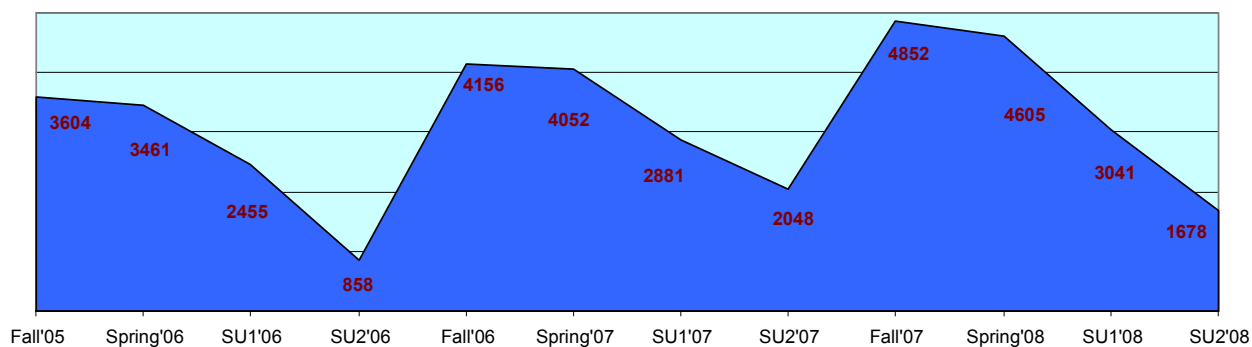
**Total number of enrolled students, 2005-08**

### Average Age of Enrolled Students, 2005-08

#### Undergraduate

Program	2005-2006	2006-2007	2007-2008
BAE	19	19	19
BAIJ	19	19	19
BSc	19	20	19
BSS	19	19	19
ALL Bachelors	19	19	19

#### Graduate

Program	2005-2006	2006-2007	2007-2008
ExMBA	-	33	33
MA	24	24	24
MAIJ	29	29	25
MATESOL	-	39	38
MBA	23	25	24
MIR	24	26	25
MPA	24	25	25
ALL Masters	25	29	28

### Average Age of Enrolled Students by Degree Level, 2005-08

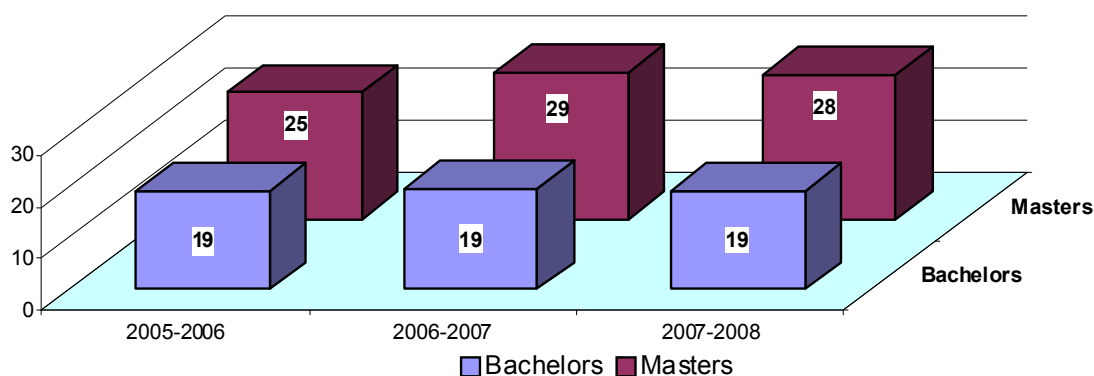

### Enrolled Students by Gender, 2005-08

#### Undergraduate

Program	2005-06				2006-07				2007-08			
	Male	%	Female	%	Male	%	Female	%	Male	%	Female	%
BAE	269	50.95%	259	49.05%	337	48.49%	358	51.51%	371	49.87%	373	50.13%
BAIJ	17	20.98%	64	79.02%	26	18.84%	112	81.16%	33	17.46%	156	82.54%
BSc	685	43.03%	907	56.97%	785	43.42%	1023	56.58%	946	42.46%	1282	57.54%
BSS	291	41.99%	402	58.01%	349	43.73%	449	56.27%	469	43.83%	601	56.17%
<b>TOTAL</b>	<b>1262</b>	<b>43.61%</b>	<b>1632</b>	<b>56.39%</b>	<b>1497</b>	<b>43.53%</b>	<b>1942</b>	<b>56.47%</b>	<b>1819</b>	<b>42.99%</b>	<b>2412</b>	<b>57.01%</b>

#### Graduate

Program	2005-06				2006-07				2007-08			
	Male	%	Female	%	Male	%	Female	%	Male	%	Female	%
MA	22	53.66%	19	46.34%	13	35.14%	24	64.86%	16	37.21%	27	62.79%
MAIJ	6	16.67%	30	83.33%	3	9.68%	28	90.32%	3	14.29%	18	85.71%
MATESOL	-	-	-	-	0	0	0	0	1	6.67%	14	93.33%
MBA	111	37.63%	184	62.37%	92	30.87%	206	69.13%	110	32.93%	224	67.07%
MIR	10	35.71%	18	64.29%	10	40.00%	15	60.00%	5	26.32%	14	73.68%
MPA	19	37.25%	32	62.75%	16	30.77%	36	69.23%	14	28.00%	36	72.00%
<b>TOTAL</b>	<b>168</b>	<b>37.25%</b>	<b>283</b>	<b>62.75%</b>	<b>134</b>	<b>30.25%</b>	<b>309</b>	<b>69.75%</b>	<b>149</b>	<b>30.91%</b>	<b>333</b>	<b>69.09%</b>

### Average Grades of Enrolled Students

#### Undergraduate

Program	F2006	S2007	SU1/2007	SU2/2007	F2007	S2008	SU1/2008	SU2/2008
BAE	B-	B-	B-	B-	C+	C	C+	C+
BAIJ	B-	B	B-	B-	B-	B-	B-	C+
BSc	B	B-	B	B	B-	B-	B	B-
BSS	B-	B-	B-	B-	C+	C+	C+	C+
Average for Bachelors	B-	B-	B-	B-	B-	C+	B-	C+

#### Graduate

Program	F2006	S2007	SU1/2007	SU2/2007	F2007	S2008	SU1/2008	SU2/2008
MA	B+	B+	B	B	B-	B	B	B
MAIJ	B+	B+	A-	B-	A-	A-	A-	-
MATESOL	-	-	A-	-	A	A-	B+	-
MBA	B+	B	B+	B+	B	B	B+	B+
MIR	B	B+	A-	A-	B	B	B	B+
MPA	B	B	B+	B+	B	B	B+	B
Average for Masters	B+	B+	B+	B	B+	B+	B+	B+

### Number of Students, Eligible to Enroll, by Programs and Gender

#### Undergraduate

Program	2005-2006 AY			2006-2007 AY			2007-2008 AY		
	Male	Female	Total	Male	Female	Total	Male	Female	Total
BAE	472	505	977	550	561	1111	610	601	1211
BAIJ	25	89	114	50	182	232	72	275	347
BSc	891	1111	2002	1201	1446	2647	1527	1949	3476
BSS	418	573	991	592	828	1420	839	1145	1984
<b>TOTAL</b>	<b>1806</b>	<b>2278</b>	<b>4084</b>	<b>2393</b>	<b>3017</b>	<b>5410</b>	<b>3048</b>	<b>3970</b>	<b>7018</b>
%	44.2%	55.8%	100.0%	44.2%	55.8%	100.0%	43.4%	56.6%	100.0%

#### Graduate

Program	2005-2006 AY			2006-2007 AY			2007-2008 AY		
	Male	Female	Total	Male	Female	Total	Male	Female	Total
MA	47	37	84	49	57	106	54	68	122
MAIJ	15	58	73	16	69	85	23	61	84
MATESOL	-	-	-	0	0	0	1	17	18
MBA	166	282	448	176	318	494	238	406	644
MIR	20	28	48	25	30	55	33	37	70
MPA	37	49	86	39	55	94	55	62	117
<b>TOTAL</b>	<b>285</b>	<b>454</b>	<b>739</b>	<b>305</b>	<b>529</b>	<b>834</b>	<b>404</b>	<b>651</b>	<b>1055</b>
%	38.6%	61.4%	100.0%	36.6%	63.4%	100.0%	38.3%	61.7%	100.0%

### Percentage of Students, Eligible to Enroll, by Programs and Gender, 2007-08

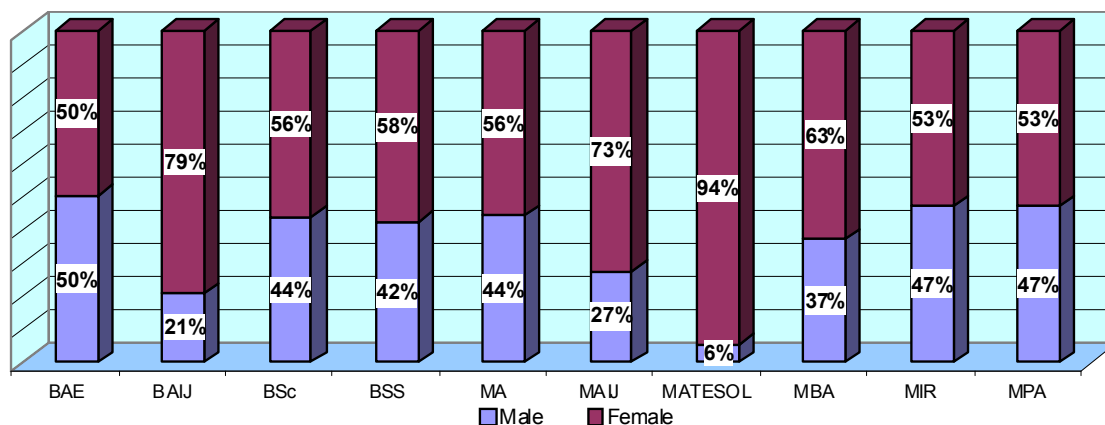

## Number of Students participating in KIMEP Exchange Programs, 2005-08

Institutions	2007-08	2006-07	2005-06	TOTAL
Aarhus School of Business, Denmark	6	4	6	16
Corvinus University of Budapest, Hungary	1	2	-	3
International Summer School at Schmalkalden, Germany	5	5	5	15
International German Language Course at Schmalkalden, Germany	1	0	0	1
Istanbul Stock Exchange, Turkey	1	0	1	2
Hong Kong Baptist University	4	4	-	8
Hunkuk University of Foreign Studies, Korea	0	3	3	6
Jönköping International Business School, Sweden	5	4	4	13
Korea University Business School	0	0	7	7
Kyung Hee University, Korea	3	4	0	7
Stockholm School of Economics, Riga, Latvia	2	2	1	5
Sungkyunkwan University, Korea	4	4	-	8
University of Applied Sciences, Schmalkalden, Germany	14	5	1	20
University of Northern Colorado, USA	1	2	2	5
Huron University, UK	2	-	-	2
Yonsei University, Korea	1	-	-	1
Ljubljana University, Slovenia	2	0	-	2
Fatih University, Turkey	4	-	-	4
Lund University, Sweden	4	-	-	4
Algarve University, Portugal	1	-	-	1
Deusto University, Spain	2	-	-	2
University of Bucharest, Romania	1	-	-	1
Humboldt university, Germany	3	-	-	3
Arnhem Business School, the Netherlands	6	-	-	6
Sogang University, Korea	1	-	-	1
Kyungsung University, Summer School, Korea	3	-	-	3
Middle East University of Technology, Turkey	1	-	-	1
Eindhoven Technical University, the Netherlands	1	-	-	1
<b>TOTAL</b>	<b>79</b>	<b>39</b>	<b>30</b>	<b>148</b>

## GRADUATED STUDENTS STATISTICS

### Total Conferred Degrees, 2005-08

	Undergraduate					Graduate						TOTAL
	BAE	BAIJ	BSc	BSS	Total	MA	MAIJ	MBA	MIR	MPA	Total	
2005-2006	36	2	195	41	274	19	13	105	10	18	164	439
2006-2007	70	8	215	56	349	12	20	69	12	14	125	476
2007-2008	52	13	264	57	386	2	6	59	4	9	80	466

### Conferred Degrees by Gender in numbers, 2005-08

Program	2005-2006			2006-2007			2007-2008		
	Male	Female	Total	Male	Female	Total	Male	Female	Total
BAE	15	21	36	27	43	70	24	28	52
BAIJ	0	2	2	2	6	8	1	12	13
BSc	75	120	195	67	148	215	106	158	264
BSS	6	35	41	18	38	56	17	40	57
<b>Total</b>	<b>96</b>	<b>178</b>	<b>274</b>	<b>114</b>	<b>235</b>	<b>349</b>	<b>148</b>	<b>238</b>	<b>386</b>
MA	10	9	19	6	6	12	1	1	2
MAIJ	3	10	13	2	18	20	1	5	6
MBA	35	70	105	21	48	69	15	44	59
MIR	4	6	10	1	11	12	2	2	4
MPA	7	11	18	3	11	14	1	8	9
<b>Total</b>	<b>59</b>	<b>106</b>	<b>165</b>	<b>33</b>	<b>94</b>	<b>127</b>	<b>20</b>	<b>60</b>	<b>80</b>
<b>TOTAL</b>	<b>155</b>	<b>284</b>	<b>439</b>	<b>147</b>	<b>329</b>	<b>476</b>	<b>168</b>	<b>298</b>	<b>466</b>

Conferred Degrees by Gender in percentage, 2005-08

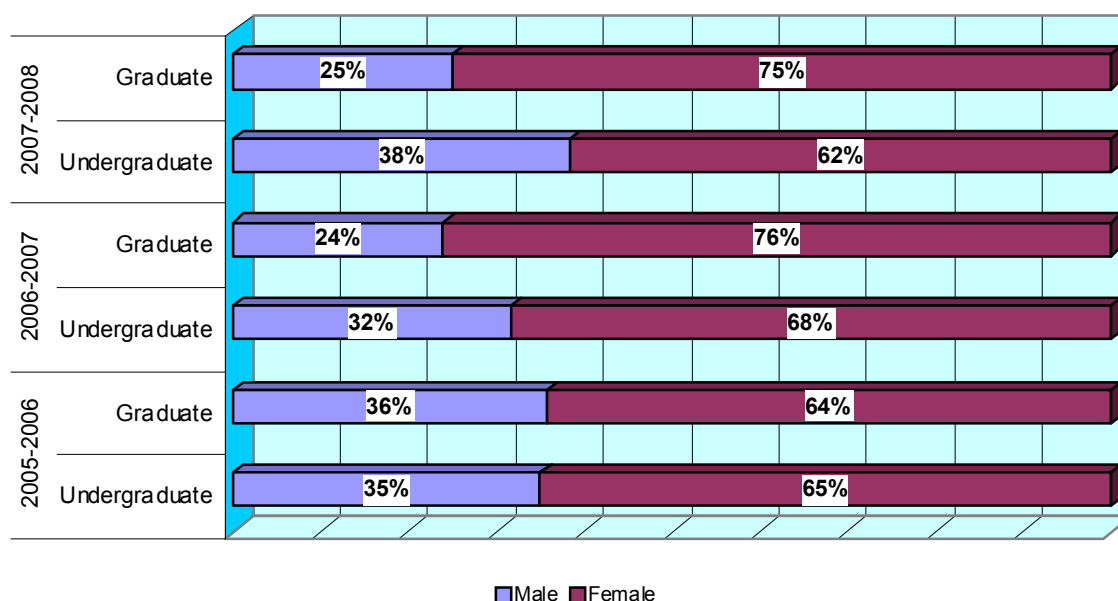

Average GPA at Graduation by Programs, 2005-08

Program	2007-2008	2006-2007	2005-2006
BAE	3.14	3.20	2.97
BAIJ	3.60	3.60	3.66
BSc	3.29	3.27	3.18
BSS	3.20	3.03	2.93
<b>Average for Undergraduates</b>	<b>3.31</b>	<b>3.28</b>	<b>3.19</b>
MA	3.32	3.67	3.7
MAIJ	3.90	3.48	3.68
MBA	3.61	3.59	3.63
MIR	3.68	3.37	3.57
MPA	3.53	3.53	3.59
<b>Average for Masters</b>	<b>3.61</b>	<b>3.53</b>	<b>3.63</b>

Length of study of Undergraduates, 2005-08

Undergraduate		Length of study in years							Total
Program	AYs	2	3	4	5	6	7	8	
BAE	2007-2008	0	2	39	7	4	0	0	52
	2006-2007	0	22	42	3	2	1	0	70
	2005-2006	0	4	26	5	1	0	0	36
BAIJ	2007-2008	0	0	9	4	0	0	0	13
	2006-2007	0	2	6	0	0	0	0	8
	2005-2006	0	1	1	0	0	0	0	2
BSc	2007-2008	1	5	204	40	10	4	0	264
	2006-2007	0	38	151	21	3	2	0	215
	2005-2006	1	23	145	22	4	0	0	195
BSS	2007-2008	0	0	39	15	2	1	0	57
	2006-2007	0	3	34	9	8	1	1	56
	2005-2006	1	0	28	7	3	2	0	41
Total	2007-2008	1	7	291	66	16	5	0	386
	2006-2007	0	65	233	33	13	4	1	349
	2005-2006	2	28	200	34	8	2	0	274



## Length of study of Graduates, 2005-08

Graduate		Length of study in years					Total
Program	AYs	1	2	3	4	5	
MA	2007-2008	1	0	0	0	1	20
	2006-2007	2	9	0	1	0	12
	2005-2006	4	12	2	1	0	19
MAIJ	2007-2008	0	4	2	0	0	20
	2006-2007	5	8	5	1	1	20
	2005-2006	1	10	2	0	0	13
MBA	2007-2008	5	10	35	8	1	69
	2006-2007	19	32	16	2	0	69
	2005-2006	22	65	16	2	0	105
MIR	2007-2008	0	2	1	0	1	12
	2006-2007	3	3	6	0	0	12
	2005-2006	1	6	1	2	0	10
MPA	2007-2008	1	1	5	2	0	14
	2006-2007	1	6	5	2	0	14
	2005-2006	2	11	3	2	0	18
Total	2007-2008	7	17	43	10	3	127
	2006-2007	30	58	32	6	1	127
	2005-2006	30	104	24	7	0	165

## STUDENT ORGANIZATIONS

## Number of KIMEP Student Organizations, 2005-08

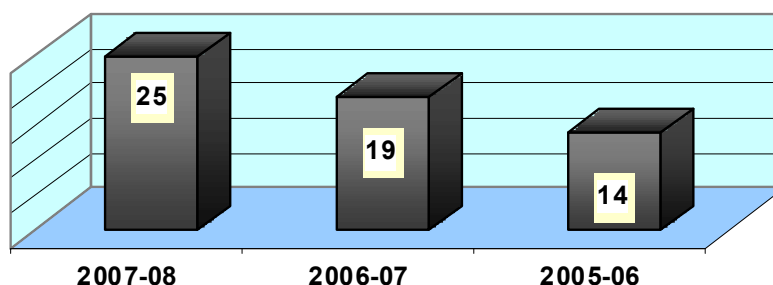

## KIMEP Speakers' Forum\*, 2005-08

Events	2007-08	2006-07	2005-06
Social events	14	0	0
Meetings	18	3	1
Conferences, seminars, lectures, workshops, consultancy sessions	10	5	5
Presentations	10	4	4
Festivals, concerts and performances	10	0	0
Contests and competitions	3	1	0
Screening of the films	13	0	0
<b>Total</b>	<b>78</b>	<b>13</b>	<b>10</b>

\*The Speakers' Forum, administered by Office of Student Affairs, is responsible for organizing social and educational events for KIMEP students

## Presidents of KIMEP Student Government, 2005-08

Presidential Term	Name	Program	Year of Entry
2007-2008	Alibek Salpekov	BSc	2005
2006-2007	Azamat Yegizbayev	BSc	2004
2005-2006	Madi Sarsenbayev	BSc	2003

## Student Organizations' List and Scope of Activity, 2005-08

Organization's name	Scope of activity	2007-08	2006-07	2005-06
AIESEC	International platform to discover and develop humankind potential to make positive impact in society	✔	✔	✔
Association of KIMEP Alumni	Association helps to connect between university and students, which graduated from it	✔	✔	-
CreATeam	Promotion of student development and enrichment of campus life	✔	✔	-
Diplomatic Briefing Club	Assistance in implementing academic knowledge in future career.	✔	✔	✔
Future Business Group (FBG)	Charity, promotion and development of student community.	✔	✔	-
Igency	Participation in fund-raising activities	✔	-	-
Intellectual Debate Club (IDC)	Development of a Debate League and social activity among KIMEP students.	✔	✔	✔
International Youth Fellowship	Community service, world camp	✔	-	-
Karandash	Development, promotion and application of students' art and decoration skills.	✔	-	-
KELT (Kazakhstan English Language Theater)	Promotion of English theater culture.	✔	✔	✔
KIMEP Cheerleader Club	Support for KIMEP sport activities.	-	✔	✔
KIMEP Culture and Language Club (KCLC)	Provision of speaking clubs for any students to improve language	✔	-	-
KIMEP Film Society	Promotion of cinema culture and awareness.	✔	✔	✔
KIMEP International Student Association (KISA)	Organization of student events and activities.	✔	✔	-
KIMEP Magic: The Gathering Club (MTG Club)	Promotion of intellectual collectible card playing game	✔	-	-
KIMEP Promo Agency	Organization of cultural student events.	✔	-	-
KIMEP Prospective Students Organization (KPSO)	Our mission is to find perspective and creative students to help them improve their talents.	✔	-	-
KIMEP SIFE (Students in Free Enterprise)	Development of students' entrepreneurial skills.	✔	✔	✔
KIMEP Sport Club	Promotion of sports and sports events.	-	✔	✔
KIMEP Student Fee Committee	Representation of interests and allocation of KIMEP students' funds.	-	✔	✔
KIMEP Times	Regular provision of relevant and interesting information about KIMEP and its students.	✔	✔	✔
KVN Team	Participation in the comic showcase 'KVN'.	✔	✔	✔
KZone	Organization of entertainment activities.	✔	-	-
Residential Assistants' Association	Facilitation of Dormitory's daily operation and safety.	✔	✔	✔
ShowTime	Organizing concert show for all students once a year	✔	✔	-
Student Government	Representation and promotion of students' interests.	✔	✔	✔
TITANS	Promotion of American Football and healthy lifestyle among students.	✔	-	-
Youth Parliament of Kazakhstan	Representation and promotion of students' interests.	✔	✔	✔
<b>Total</b>		<b>25</b>	<b>19</b>	<b>14</b>

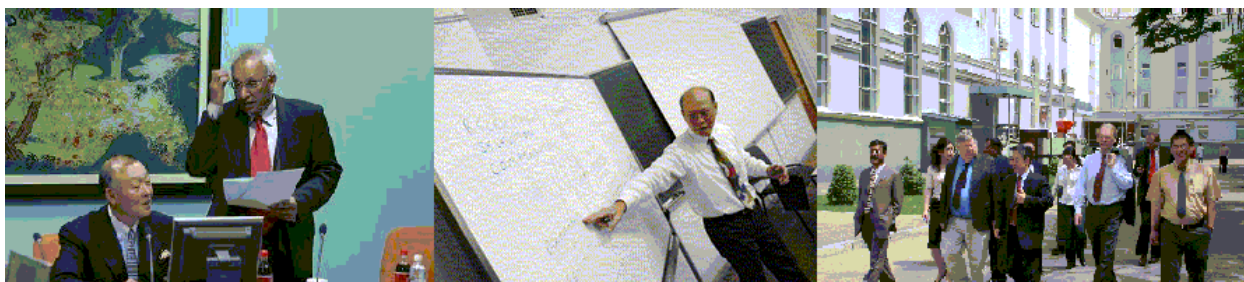

## FACULTY BODY STATISTICS\*

### NUMBER AND SCOPE

Dynamics of Faculty Members Headcount, 2005-08

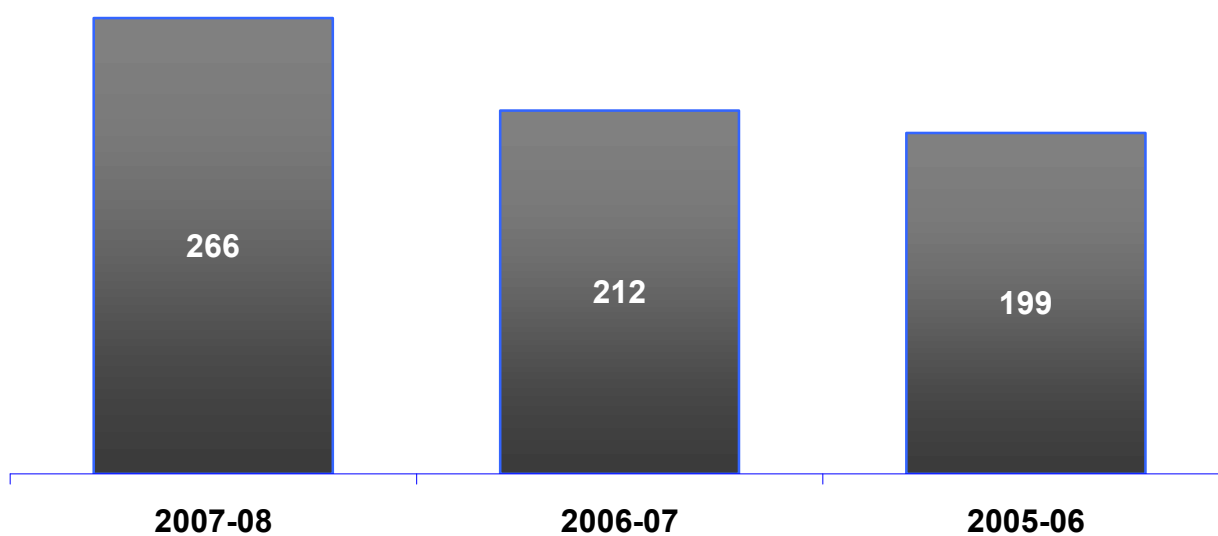

Faculty Members Composition by Degree, 2005-08

	2007-08	2006-07	2005-06
Ph.D.	65	51	43
Doctor of Science	9	9	10
Candidate of Science	34	29	21
Masters and otherwise qualified	158	123	125
<b>TOTAL</b>	<b>266</b>	<b>212</b>	<b>199</b>

\* Data was provided by Office of Registrar, Human Resource Department and Office of Vice-President of Academic Affairs

## Full Time and Part Time Faculty Members at Colleges and Centers, 2005-08

Departments	2005-2006		2006-2007		2007-2008	
	Full-time	Part-time	Full-time	Part-time	Full-time	Part-time
Bang College of Business	43	11	47	7	52	8
College of Social Sciences	58	16	56	24	60	26
Language Center	51	15	54	18	79	35
Computer and Information Systems Center	5	0	6	0	6	0
<b>TOTAL</b>	<b>157</b>	<b>42</b>	<b>163</b>	<b>49</b>	<b>197</b>	<b>69</b>

## Faculty Members' Countries of Origin, 2005-08

Countries	2007-08	2006-07	2005-06
Armenia	●	-	-
Australia	●	-	-
Bangladesh	●	●	●
Canada	●	●	●
Chile	●	●	●
France	●	●	●
Germany	-	-	●
Great Britain	●	●	●
India	●	●	●
Iran	-	●	-
Ireland	-	●	●
Italy	-	●	●
Japan	●	-	-
Kazakhstan	●	●	●
Kyrgyzstan	-	-	●
Mauritius	●	-	-
Nigeria	-	●	●
Netherlands	●	●	-
Pakistan	●	●	-
Poland	-	-	●
Portugal	-	●	●
Romania	-	-	●
Russia	●	-	●
Singapore	-	-	●
South Africa	●	-	●
South Korea	●	●	●
Turkey	●	●	●
USA	●	●	●
<b>TOTAL</b>	<b>18</b>	<b>17</b>	<b>21</b>

**PROFESSIONAL DEVELOPMENT**

## KIMEP Faculty Members Studying at KIMEP

Year	Program	Unit	Number
2007-08	DBA	BCB	2
	MATESOL	Language Center	4
	MBA	Language Center	1
2006-07	MATESOL	Language Center	5
	MBA	Language Center	1
	MPA	Language Center	1
2005-06	DBA	BCB	1
		Language Center	1
	MAIJ	Language Center	1
	MBA	Language Center	1
<b>TOTAL</b>			<b>18</b>

**KIMEP Faculty Members Studying Abroad, 2005-06**

College	Position, current degree	Degree to obtain/ Specialization		Country/University
<b>BCB</b>	1. Senior Lecturer, MPhil	PhD/ Marketing		USA/University of Mississippi
	2. Senior Lecturer, MA	PhD/ Finance		USA/University of Illinois
<b>CSS</b>	1. Lecturer, MA	PhD/ Political Science		USA/New School University of Social Research
<b>TOTAL</b>	<i>3 faculty members</i>	<i>PhD studies</i>	<b>3</b>	<i>3 universities</i>

**KIMEP Faculty Members Studying Abroad, 2006-07**

College	Position, current degree	Degree to obtain/ Specialization		Country/University
<b>CSS</b>	1. Senior Lecturer, MA	PhD/Political Science		Finland/Tampere University
	2. Senior Lecturer, MA	PhD/Political Science		USA/ University of South Carolina
	3. Senior Lecturer, MA	PhD/Political Science and Public Policy		USA/ George Washington University
	4. Lecturer, MBA	PhD/Economics		USA/Michigan State University
<b>LC</b>	1. Senior Lecturer, MA	PhD/Language, Discourse and Communication		UK/University of London
<b>TOTAL</b>	<i>5 faculty members</i>	<i>PhD studies</i>	<b>5</b>	<i>5 universities</i>

**KIMEP Faculty Members Studying Abroad, 2007-08**

College	Position, current degree	Degree to obtain/ Specialization		Country/University
<b>BCB</b>	1. Lecturer, MA	PhD/ Economics		USA/State University of New York
	2. Lecturer, MBA	PhD/ Strategic Management		Sweden/ Lund University
	3. Senior Lecturer, MPhil	PhD/Business Administration and Marketing		USA/University of Mississippi
	4. Senior Lecturer, MA	PhD/ Marketing		Switzerland/University of Geneva
	5. Senior Lecturer, MA	PhD/ Finance		USA/ University of Illinois
	6. Senior Lecturer, MA	PhD/ Statistics		UK/Bath University
<b>CSS</b>	1. Lecturer, MA	PhD/ Political Science		USA/New School University of Social Research
	2. Lecturer, MSc	PhD/Politics		UK/ Oxford University
	3. Lecturer, MBA	PhD/Economics		USA/Michigan State University
	4. Lecturer, MA	PhD/Electronic Engineering		Dutch University, Netherlands
	5. Senior Lecturer, MA	PhD/Political Science		Finland/Tampere University
	6. Senior Lecturer, MA	PhD/Political Science		USA/ University of South Carolina
	7. Senior Lecturer, MA	PhD/Political Science and Public Policy		USA/ George Washington University
<b>LC</b>	1. Instructor, BA	MA/Applied Linguistics and TESOL		UK/University of Leicester
	2. Senior Lecturer, MA	PhD/Language, Discourse and Communication		UK/University of London
	3. Senior Lecturer, Doctor	Post-doctoral Research Scholarship/ Applied Linguistics		USA/ Indiana University
<b>TOTAL</b>	<i>17 faculty members</i>	<i>Masters degree</i>	<b>1</b>	<i>17 universities</i>
		<i>PhD studies</i>	<b>14</b>	
		<i>Post-doctoral</i>	<b>2</b>	

**RESEARCH ACTIVITY BY DEPARTMENTS, 2005-2008 AYs**

<b>KIMEP Grants Awarded, numbers:</b>	<b>2007-08</b>	<b>2006-07</b>	<b>2005-06</b>	<b>Total</b>
<b>College of Social Sciences</b>	<b>0</b>	<b>4</b>	<b>12</b>	<b>16</b>
Economics	0	1	4	5
Journalism and Mass Communications	0	0	1	1
Public Administration	0	0	3	3
Political Science	0	3	4	7
<b>Bang College of Business</b>	<b>9</b>	<b>12</b>	<b>5</b>	<b>26</b>
Accounting	2	2	-	4
Finance	3	3	2	8
Management and Marketing	2	2	2	6
Operations Management and Information Systems	2	5	1	8
<b>College of Continuing Education</b>	<b>0</b>	<b>0</b>	<b>0</b>	<b>0</b>
<b>Computer and Information Systems Center</b>	<b>0</b>	<b>0</b>	<b>0</b>	<b>0</b>
<b>Language Center</b>	<b>0</b>	<b>1</b>	<b>1</b>	<b>2</b>
<b>TOTAL</b>	<b>9</b>	<b>17</b>	<b>18</b>	<b>44</b>

<b>KIMEP Grants Awarded, cost, USD:</b>	<b>2007-08</b>	<b>2006-07</b>	<b>2005-06</b>	<b>Total</b>
<b>College of Social Sciences</b>	<b>0</b>	<b>7,248</b>	<b>11,680</b>	<b>18,928</b>
Economics	0	500	6,380	6,880
Journalism and Mass Communications	0	0	500	500
Public Administration	0	0	1,400	1,400
Political Science	0	6,748	3,400	10,148
<b>Bang College of Business</b>	<b>44,517</b>	<b>22,916</b>	<b>3,490</b>	<b>70,923</b>
Accounting	3,500	3,500	0	7,000
Finance	8,067	8,579	1,000	17,646
Management and Marketing	9,450	3,950	1,990	15,390
Operations Management and Information Systems	23,500	6,887	500	30,887
<b>College of Continuing Education</b>	<b>0</b>	<b>0</b>	<b>0</b>	<b>0</b>
<b>Computer and Information Systems Center</b>	<b>0</b>	<b>0</b>	<b>0</b>	<b>0</b>
<b>Language Center</b>	<b>5,000</b>	<b>2,000</b>	<b>900</b>	<b>7,900</b>
<b>TOTAL</b>	<b>49,517</b>	<b>32,164</b>	<b>16,070</b>	<b>97,751</b>

<b>Non- KIMEP Grants Awarded, numbers:</b>	<b>2007-08</b>	<b>2006-07</b>	<b>2005-06</b>	<b>Total</b>
<b>College of Social Sciences</b>	<b>3</b>	<b>2</b>	<b>3</b>	<b>8</b>
Economics	2	1	1	4
Journalism and Mass Communications	0	1	1	2
Public Administration	1	0	0	1
Political Science	0	0	1	1
<b>Bang College of Business</b>	<b>2</b>	<b>3</b>	<b>7</b>	<b>12</b>
Accounting	1	1	1	3
Finance	0	0	2	2
Management and Marketing	0	2	3	5
Operations Management and Information Systems	1	0	1	2
<b>College of Continuing Education</b>	<b>0</b>	<b>0</b>	<b>0</b>	<b>0</b>
<b>Computer and Information Systems Center</b>	<b>0</b>	<b>0</b>	<b>0</b>	<b>0</b>
<b>Language Center</b>	<b>0</b>	<b>0</b>	<b>0</b>	<b>0</b>
<b>TOTAL</b>	<b>5</b>	<b>5</b>	<b>10</b>	<b>20</b>

<b>Non-KIMEP Grants Awarded, cost, USD:</b>	<b>2007-08</b>	<b>2006-07</b>	<b>2005-06</b>	<b>Total</b>
<b>College of Social Sciences</b>	<b>63,750</b>	<b>9,600</b>	<b>304,500</b>	<b>377,850</b>
Economics	56,750	9,600	0	66,350
Journalism and Mass Communications	0	0	300,000	300,000
Public Administration	7,000	0	0	7,000
Political Science	0	0	4,500	4,500
<b>Bang College of Business</b>	<b>65,250</b>	<b>26,400</b>	<b>46,216</b>	<b>137,866</b>
Accounting	0	5,400	1,080	6,480
Finance	8,500	0	13,500	22,000
Management and Marketing	0	21,000	25,636	46,636
Operations Management and Information Systems	56,750	0	6,000	62,750
<b>College of Continuing Education</b>	<b>0</b>	<b>0</b>	<b>0</b>	<b>0</b>
<b>Computer and Information Systems Center</b>	<b>0</b>	<b>0</b>	<b>0</b>	<b>0</b>
<b>Language Center</b>	<b>48,000</b>	<b>0</b>	<b>0</b>	<b>48,000</b>
<b>TOTAL</b>	<b>177,000</b>	<b>36,000</b>	<b>350,716</b>	<b>563,716</b>

<b>Consulting Contracts Carried out, numbers:</b>	<b>2007-08</b>	<b>2006-07</b>	<b>2005-06</b>	<b>Total</b>
<b>College of Social Sciences</b>	<b>2</b>	<b>0</b>	<b>0</b>	<b>2</b>
Economics	0	0	0	0
Journalism and Mass Communications	0	0	0	0
Public Administration	0	0	0	0
Political Science	2	0	0	2
<b>Bang College of Business</b>	<b>11</b>	<b>2</b>	<b>0</b>	<b>13</b>
Accounting	1	0	0	1
Finance	8	2	0	10
Management and Marketing	2	0	0	2
Operations Management and Information Systems	0	0	0	0
<b>College of Continuing Education</b>	<b>1</b>	<b>0</b>	<b>0</b>	<b>1</b>
<b>Computer and Information Systems Center</b>	<b>0</b>	<b>0</b>	<b>0</b>	<b>0</b>
<b>Language Center</b>	<b>0</b>	<b>0</b>	<b>0</b>	<b>0</b>
<b>TOTAL</b>	<b>14</b>	<b>2</b>	<b>0</b>	<b>16</b>

<b>Conferences Attended, numbers:</b>	<b>2007-08</b>	<b>2006-07</b>	<b>2005-06</b>	<b>Total</b>
<b>College of Social Sciences</b>	<b>21</b>	<b>59</b>	<b>23</b>	<b>103</b>
Economics	4	7	7	18
Journalism and Mass Communications	7	32	4	43
Public Administration	4	2	5	11
Political Science	6	18	7	31
<b>Bang College of Business</b>	<b>10</b>	<b>27</b>	<b>50</b>	<b>87</b>
Accounting	0	0	1	1
Finance	1	6	16	23
Management and Marketing	3	7	14	24
Operations Management and Information Systems	6	14	19	39
<b>College of Continuing Education</b>	<b>0</b>	<b>0</b>	<b>0</b>	<b>0</b>
<b>Computer and Information Systems Center</b>	<b>0</b>	<b>0</b>	<b>0</b>	<b>0</b>
<b>Language Center</b>	<b>15</b>	<b>11</b>	<b>4</b>	<b>30</b>
<b>TOTAL</b>	<b>46</b>	<b>97</b>	<b>77</b>	<b>220</b>

<b>Publications, numbers:</b>	<b>2007-08</b>	<b>2006-07</b>	<b>2005-06</b>	<b>Total</b>
<b>College of Social Sciences</b>	<b>43</b>	<b>27</b>	<b>22</b>	<b>92</b>
Economics	13	9	8	30
Journalism and Mass Communications	4	3	4	11
Public Administration	7	4	1	12
Political Science	19	11	9	39
<b>Bang College of Business</b>	<b>51</b>	<b>78</b>	<b>49</b>	<b>178</b>
Accounting	9	11	8	28
Finance	10	16	20	46
Management and Marketing	15	17	7	39
Operations Management and Information Systems	17	34	14	65
<b>College of Continuing Education</b>	<b>0</b>	<b>0</b>	<b>0</b>	<b>0</b>
<b>Computer and Information Systems Center</b>	<b>0</b>	<b>0</b>	<b>0</b>	<b>0</b>
<b>Language Center</b>	<b>35</b>	<b>43</b>	<b>25</b>	<b>103</b>
<b>TOTAL</b>	<b>129</b>	<b>148</b>	<b>96</b>	<b>373</b>



## ALUMNI\*

### NUMBER AND SCOPE

Total number of KIMEP Alumni, 1994-08

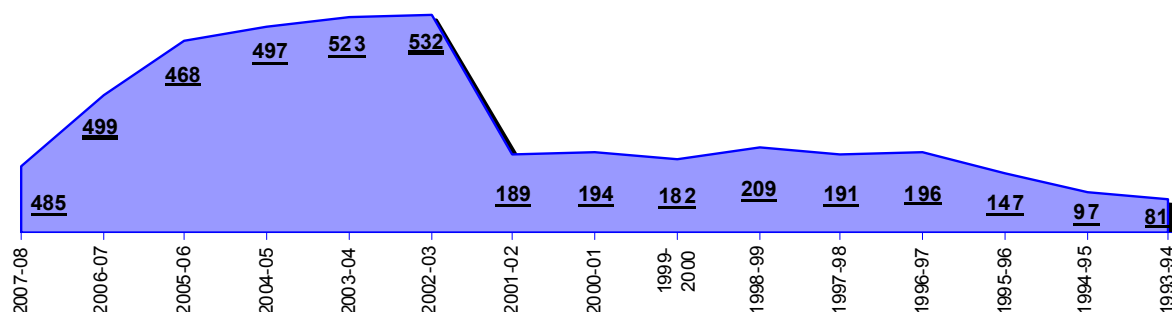

Number of Alumni by Program, 1994-08

<i>Undergraduate</i>	2007-08	2006-07	2005-06	2004-05	2003-04	2003-1994	Total
BSc	264	215	195	192	164	251	1281
BSS	57	56	41	52	67	74	347
BAE	52	70	36	47	29	0	234
BAIJ	13	8	2	0	0	0	23
<b>TOTAL</b>	<b>386</b>	<b>349</b>	<b>274</b>	<b>291</b>	<b>260</b>	<b>325</b>	<b>1885</b>
<i>Graduate</i>	2007-08	2006-07	2005-06	2004-05	2003-04	2003-1994	Total
MBA	59	69	105	85	72	921	1311
MA	2	12	19	14	50	356	453
MPA	9	14	18	15	21	183	260
MIR	4	12	10	7	2	0	35
MAIJ	6	20	13	17	13	0	69
EMBA	19	23	29	68	105	233	477
<b>TOTAL</b>	<b>99</b>	<b>150</b>	<b>194</b>	<b>206</b>	<b>263</b>	<b>1693</b>	<b>2605</b>

Number of Alumni Employed or Further Studying, 2003-07

	<i>Undergraduate</i>				<i>Graduate</i>				
	BSc	BSS	BAE	BAIJ	MBA	MA	MPA	MIR	MAIJ
2007**	158	33	45	6	66	15	10	8	14
2006	158	32	32	1	101	16	14	4	19
2005	166	41	34	0	72	13	14	4	15
2004	141	57	26	0	65	54	24	1	5
2003	206	55	0	0	49	40	19	0	0

\*\*Data is provided as of the end of designated calendar year.

\* Data was provided by Office of the Registrar, Career and Employment Center, Corporate Development Department and QAIR.



## EMPLOYMENT AND SALARY

### Factors assisting in getting first job after graduating from KIMEP, 2005<sup>♦</sup>

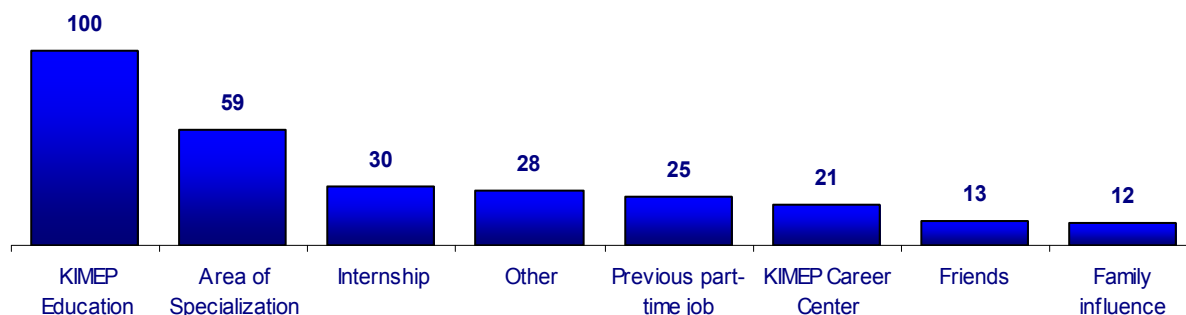

### Factors assisting in getting first job after graduating from KIMEP, 2006<sup>♦</sup>

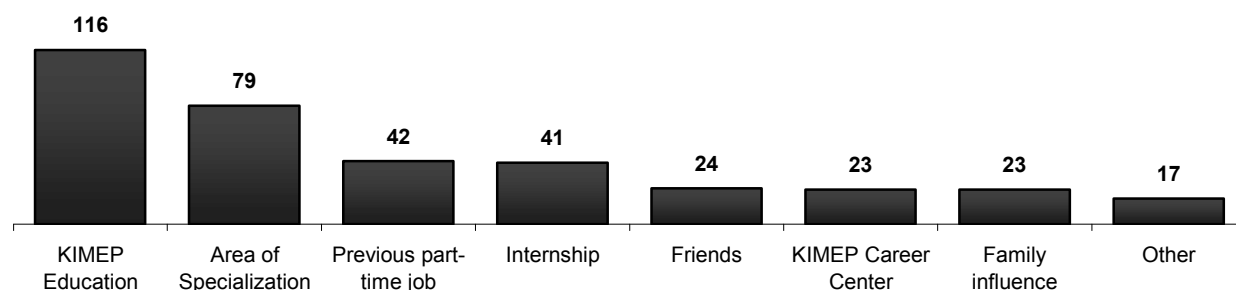

<sup>♦</sup>Data from QA&IR Report on Alumni Survey Results: graduates of AYs 1993-2006

### Fields of Alumni's Employment, 2005-07

Fields of Alumni's Employment, %	2007	2006	2005
Advertising	1.2	1.9	4.17
Audit	36.9	25.2	21.57
Banking	10.7	11.3	11.03
Construction	2.5	2.8	1.71
Education	12.3	13.4	16.91
Embassy, NGO, Public sector	1.6	2.1	6.13
Energy	0.4	0.9	0.49
Finance	3.7	10.2	3.19
Insurance	2	0	0
Media	6.6	0	0
Oil & Gas	4.9	3.4	6.86
Other	0.8	6.4	7.6
Production	2.5	3.8	4.9
Telecommunications	0	1.9	2.7
Trade/Services	14.3	15.4	12.5
Transport	0.4	1.3	0.25

Salary Level of KIMEP Alumni 2005 (USD)

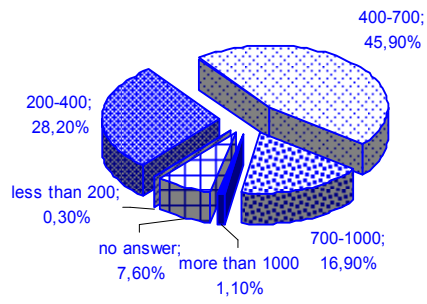

Salary Level of KIMEP Alumni 2006 (USD)

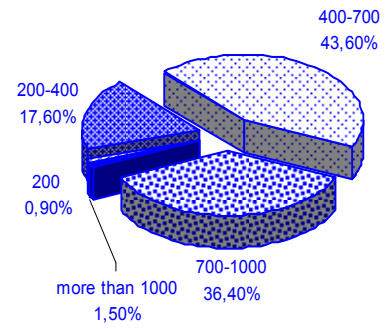

Salary Level of KIMEP Alumni 2007 (USD)

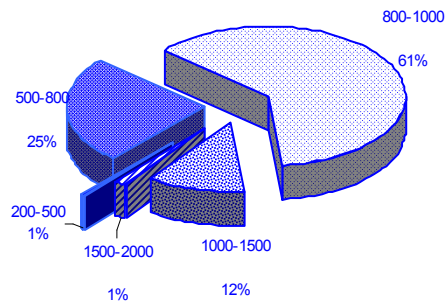

# Success Stories

of KIMEP 1997-2000 Alumni



**GULNARA AKHMETOVA, MBA, 1997**

DEPUTY DIRECTOR, PETROKAZAKHSTAN TRADING HOUSE

*I do remember the last day at KIMEP, when after the lecture, we organized an excellent party. Being extremely excited of KIMEP graduation I wrote at the classroom board: "KIMEP, you've given the future to us!"*

*Now, after almost 11 years, I can repeat my statement. Without the knowledge and skills, received in KIMEP, I would have never got the interesting jobs and high positions in different companies as local so multinational as well: Coca-Cola, Kazatomprom, Citibank, and currently Petrokazakhstan. I am grateful to KIMEP's professors, management, and my brilliant classmates for everything that I have achieved so far and for the future achievements that I will have.*

**YEVGENIY KOPAIGORA, MBA, 1998**

HEAD OF INTERNAL AUDIT & RISK MANAGEMENT, KAR-TEL LLP

*Right after KIMEP graduation in 1998 I joined Philip Morris Kazakhstan (at that time – Almaty Tobacco Company). I spent 8 years there working in finance, project management, internal controls and compliance. Now I'm with Kar-Tel LLP (leading mobile operator with Beeline brand name).*

*KIMEP gave me a lot, especially taught me to find, gather and process information. I still keep in touch with my KIMEP peers, graduates of other years, students. I use my KIMEP database as a talent pool for myself and my friends, as we are all employers. If you are not yet there – welcome! ☺*



**AIDAR UTKELOV, MPA, 1998**

PRESIDENT, ALMATY ASSOCIATION OF REALTORS OF KAZAKHSTAN

*For me KIMEP has always been and still remains to be not only the most privileged high school of the Republic, but also a place, which gave me the future.*

*The knowledge and skills acquired at KIMEP allow me to be always on top of the matters.*

**DILBAR GIMRANOVA, MBA, 2000**

CHAIR OF THE DEPARTMENT OF MANAGEMENT AND MARKETING, BCB, KIMEP

*Right after graduation, I joined Department of Business Administration of KIMEP as a lecturer. Currently, I work with BCB, AMA Program, and CEEPDP.*

*KIMEP has made a valuable contribution to my career and professionalism. It gave me the wonderful opportunity to study in the joint MPhil Program of KIMEP and Maastricht School of Management. Last Fall, I was accepted to the DBA program of KIMEP. I am sure that KIMEP is the best Kazakhstani University in the realm of business education.*



# Success Stories

of KIMEP 2001-2007 Alumni

## ARMAN ZHOLDASBEKOV, MBA, 2001

GENERAL DIRECTOR, PLAST-INVEST COMPANY

*I entered KIMEP in 1999 being already an entrepreneur. At that time, many people asked me why I decided to study at KIMEP, whereas I could earn a living. However, I felt the crisis in my professional evolution and the need to raise social status.*

*The two years had passed very rapidly and I can declare that it was the most exciting time in my life! At present I am the Head of Plast Invest LLP, fast growing company involved in water network construction business and the largest dealer of Chevron-Texaco Polyethylene Pipes plant based in Atyrau.*



## DIDAR ZHUMAGULOV, MBA, 2003

EXECUTIVE DIRECTOR, ADG GROUP-AK

*I have only positive memories connected to KIMEP. KIMEP taught me professionalism, discipline, and leadership. I am grateful to KIMEP for enabling me to become a professional in the business.*

## AIDA SAPARGAZINOVA, ExMBA 2004

GENERAL DIRECTOR, LACTALIS-FOODMASTER, KAZAKHSTAN

*For over 15 years KIMEP has been preparing specialists of high international level for the benefit of Kazakhstani economy. Many top managers of "FoodMaster" Company worked and studied at the same time. It was not easy - instructors did not indulge us, we had to put all our physical and mental efforts to study, but the result exceeded all expectations.*

*Today I am confident that knowledge obtained at KIMEP is in demand and helps me in my work.*



## GULMARA RYSBEKOVA, BSc, 2006 and MBA, 2007

HEAD OF MARKETING OF FINANCIAL PORTALS DIVISION, "KAZKOMMERTSBANK"

*I'm grateful to KIMEP for all the professors who have given us good knowledge and who have coached us over the years of study. KIMEP's projects, deadlines, teamwork and presentations made me organized, responsible and target-oriented person. After graduating from BSc program, it was much easier for me to graduate from MBA over 9 months due to the knowledge that I've received over 4 years of study at bachelor program of KIMEP.*

*I would like to thank the whole KIMEP community that contributed to my career, especially the Career Center of KIMEP that helped me to find my current job. I'm glad to work at KAZKOM and I can say that the knowledge that I've received at KIMEP is the best asset that I've acquired in my life."*



## ACADEMIC PROGRAMS AND SPECIALIZATIONS\*

### GRADUATE PROGRAMS

	2008-09	2007-08	2006-07	2005-06
<b>DOCTORAL DEGREES</b>				
<b>Doctor of Business Administration (DBA)</b>				
Accounting	✓	✓	✓	✓
Finance	✓	✓	✓	✓
Management	✓	✓	✓	✓
Marketing	✓	✓	✓	✓
Operations Management & Information Systems	✓	✓	✓	✓
<b>TOTAL DOCTORAL DEGREES</b>	<b>5</b>	<b>5</b>	<b>5</b>	<b>5</b>
<b>MASTER DEGREES</b>				
<b>Master of Business Administration (MBA)</b>				
Accounting	✓	✓	✓	✓
Finance	✓	✓	✓	✓
Information Systems	✓	✓	✓	✓
Management	✓	✓	✓	✓
Marketing	✓	✓	✓	✓
Operations Management	✓	✓	✓	✓
<b>Executive Master of Business Administration (ExMBA)</b>	✓	✓	✓	✓
<b>Master of International Business (MIB)</b>				✓
<b>Master of Arts in Economics (MA)</b>				
Financial Analysis	✓	✓	✓	✓
International Economics	✓	✓	✓	✓
Public Policy Economics	✓	✓	✓	✓
<b>Master in International Relations (MIR)</b>	✓	✓	✓	✓
<b>Master in Public Administration (MPA)</b>				
Financial Management	✓	✓		
Research & Information Technology				✓
Natural Resource Management			✓	✓
Public Finance			✓	✓
Public Finance & Management			✓	✓
Public Management	✓	✓	✓	✓
Public Policy	✓	✓	✓	✓
<b>Master of Arts in International Journalism (MAIJ)</b>				
Media Management	✓		✓	✓
Print and Broadcast Journalism	✓	✓	✓	✓
Public Relations	✓	✓	✓	✓
<b>Master of Arts in Teaching English to Speakers of Other Languages (MA in TESOL)</b>	✓	✓		
<b>Master of Law in International Business Law</b>	✓			
<b>TOTAL MASTER DEGREES</b>	<b>19</b>	<b>17</b>	<b>19</b>	<b>20</b>
<b>TOTAL NUMBER OF PROGRAMS</b>	<b>24</b>	<b>22</b>	<b>24</b>	<b>25</b>

\* Information is taken from KIMEP Catalog of respective academic years.

## UNDERGRADUATE PROGRAMS

	2008-09	2007-08	2006-07	2005-06
<b>BACHELOR DEGREES</b>				
<b>Bachelor of Science in Business Administration and Accounting (BSc)</b>				
Accounting	✓	✓	✓	✓
Finance	✓	✓	✓	✓
Information Systems	✓	✓	✓	✓
Management	✓	✓	✓	✓
Marketing	✓	✓	✓	✓
Operations Management	✓	✓	✓	✓
Human Resource Management	✓	✓	✓	
<b>Bachelor of Arts in Economics (BAE)</b>				
Business Economics	✓	✓	✓	✓
Public Policy Economics	✓	✓	✓	✓
Resource and Environmental Economics			✓	✓
<b>Bachelor of Social Science (BSS)</b>				
Central Asian Politics	✓	✓	✓	✓
Comparative Politics	✓			
History		✓		
International Relations	✓	✓	✓	✓
Foreign Policy and Diplomacy	✓			
International Security	✓			
Law		✓		
Political Science		✓	✓	✓
Public Administration			✓	✓
Public Policy and Administration	✓	✓		
Public Management	✓		✓	✓
Financial Management	✓		✓	✓
Health Policy and Administration		✓		
Natural Resource Management	✓		✓	✓
<b>Bachelor of Arts in International Journalism (BAIJ)</b>				
Media Management	✓	✓		
Print, Broadcast and Online Journalism	✓	✓		
Public Relations	✓	✓		
<b>TOTAL NUMBER OF PROGRAMS</b>	<b>21</b>	<b>19</b>	<b>18</b>	<b>17</b>

### Number of Specializations: Bachelor, Master and Doctoral Programs, 2005-09

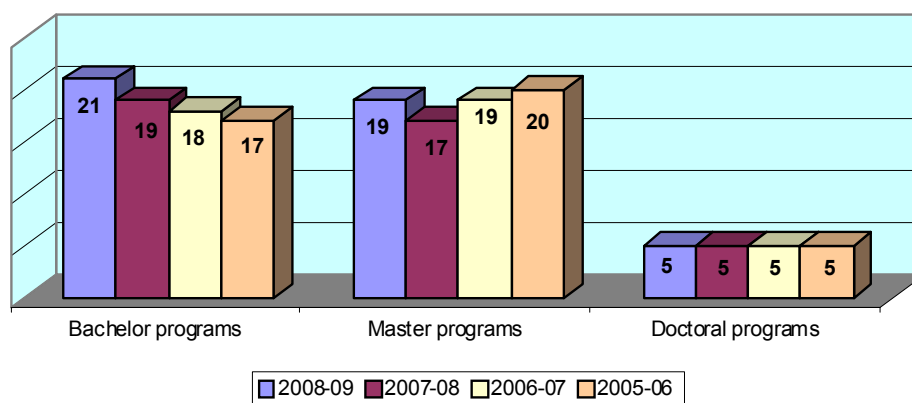



## FINANCIAL AID AND FEES\*

### FINANCIAL AID (FINAID)

#### Corporate-Funded FinAid, 2005-08

Sponsors of Financial Aid	2007-08 <i>thous. KZT</i>			2006-07 <i>thous. KZT</i>			2005-06 <i>thous. KZT</i>		
	SU I-II	Spring	Fall	SU I-II	Spring	Fall	SU I-II	Spring	Fall
AGIP KCO	0	113	0	0	0	1,056	0	0	0
Almaty International Women Club	74	288	302	0	0	0	0	0	0
Apple City Group	0	0	0	0	0	33	0	0	0
Bilim-Central Asia	0	211	2,239	0	0	562	0	0	0
Citibank Kazakhstan	0	0	0	0	0	13	0	0	0
Deloitte&Touche LLP	244	0	0	244	0	819	0	0	0
Dr.Sumitro Djojohadikusumo	0	585	586	0	585	585	0	412	389
Ernst & Young	0	0	0	0	0	0	0	0	234
Erzhan Tatishev Foundation	340	619	506	83	0	0	0	0	0
Jeewoo Venture Capital Co., LTD	0	0	0	0	29	0	0	377	0
JSC "Procter and Gamble"	0	0	0	47	230	0	0	0	0
Karachaganak Petroleum Operating B.V.	0	56	253	0	0	314	0	0	0
Kazmunaigaz	0	1,350	900	0	0	0	0	0	0
Kazmunaigaz Consulting	22	56	44	0	0	0	0	0	0
KEGOC	210	280	283	0	0	0	0	0	0
KookminBank	241	2,630	1,953	0	0	0	0	0	0
Kus Zholy Foundation / KKB	175	2,245	2,683	0	0	0	0	0	0
PetroKazakhstan Kumkol Resources	608	1,854	2,054	324	126	2,410	28	237	1,678
Philip Morris Kazakhstan OJSC	0	0	0	0	0	0	0	0	0
Pricewaterhouse Coopers LLP	0	3,774	0	0	0	0	0	0	0
SB HSBC Bank Kazakhstan JSC	0	0	0	0	0	0	0	0	459
State Presidential Stipend	386	965	965	386	965	965	386	965	965
Tarlan Scholarship	-	-	-	-	-	-	-	-	13
Tengizchevroil LLP	22	3,142	6,877	0	0	9,750	0	0	11,767
The Eurasia Foundation of Central Asia	0	1,847	1,931	63	934	1,947	0	4,762	2,769
Trilateral Contracts	66,248	32,645	123,106	23,865	13,970	56,131	7,099	6,715	43,335
Turgai Petroleum	0	260	140	0	0	0	0	0	0
Tyub-Karagan Scholarship	0	0	0	0	0	1,200	0	0	1,656
US-Central Asia Education Foundation Fellowship	0	4,596	4,318	0	0	0	0	0	0
USAID Scholarship	0	0	0	0	0	0	225	1,572	1,919
<b>GRAND TOTAL</b>	<b>68,570</b>	<b>57,516</b>	<b>149,140</b>	<b>25,012</b>	<b>16,839</b>	<b>75,785</b>	<b>7,738</b>	<b>15,040</b>	<b>65,184</b>

\* Data received from Student Financial Services Sector of the Office of the Registrar and Corporate Development Department.

## KIMEP-Funded FinAid, 2005-08

Type of Financial Aid	2007-08 <i>thous. KZT</i>			2006-07 <i>thous. KZT</i>			2005-06 <i>thous. KZT</i>		
	SU I-II	Spring	Fall	SU I-II	Spring	Fall	SU I-II	Spring	Fall
Altyn Belgi Scholarship	2,495	6,650	6,057	797	2,301	2,404	114	663	1,243
Caucasus Scholarship	0	553	901	84	393	488	0	0	0
Central Asian Scholarship	786	2,400	3,190	1,042	3,397	3,914	662	1,854	1,742
Nursultan Nazarbayev Scholarship	1,339	5,177	6,280	302	1,406	1,705	471	926	1,504
Ethnic Minority Scholarship	0	0	0	0	0	0	0	270	232
KIMEP Presidential Scholarship	0	6,926	9,046	0	2,878	3,125	0	682	1,802
KIMEP Dean's Scholarship	0	4,089	4,838	0	1,018	1,194	0	759	817
KIMEP/EURASIA Scholarship	0	180	263	16	249	639	0	827	923
KIMEP/US-Central Asia Education Foundation Fellowship	83	2,048	1,829	0	0	0	0	0	0
KIMEP/USAID Scholarship	0	0	0	0	0	0	0	572	675
KIMEP Family Work-Study Tuition Discounts	1,670	5,908	6,616	995	2,728	3,740	0	1,444	1,974
Work-Study Tuition Discounts for Children of Pensioners	721	1,657	1,723	276	817	1,290	0	766	1,145
Work-Study Tuition Discounts for Children with a Single Parent	4,452	12,234	12,523	2,528	6,832	9,225	0	3,634	5,448
Work-Study Tuition Discounts for Orphans	1,295	4,676	4,659	754	2,532	2,276	202	794	762
Tuition Waiver for Children of KIMEP Employees	673	3,494	3,735	1,058	2,192	2,012	401	1,901	2,716
<b>TOTAL</b>	<b>13,514</b>	<b>55,991</b>	<b>61,661</b>	<b>7,850</b>	<b>26,744</b>	<b>32,010</b>	<b>1,851</b>	<b>15,093</b>	<b>20,983</b>
KIMEP Tuition Waiver	679	1,495	3,039	294	920	2,015	398	2,731	1,348
Letters	183	818	1,170	63	792	466	125	194	0
<b>GRAND TOTAL</b>	<b>14,376</b>	<b>58,303</b>	<b>65,870</b>	<b>8,207</b>	<b>28,455</b>	<b>34,491</b>	<b>2,374</b>	<b>18,018</b>	<b>22,331</b>



**TUITION\*, KZT**

Kazakhstan and CIS, Graduate		2008-09	2007-08	2006-07	2005-06
DBA	per 1 credit	131,440	109,540	109,545	-
	3 credits/ 1 course	394,320	328,620	328,635	-
MBA	per 1 credit	32,800	27,340	23,170	20,150
	3 credits/ 1 course	98,400	82,020	69,510	60,450
MA	per 1 credit	31,330	26,110	22,130	19,240
	3 credits/ 1 course	93,990	78,330	66,390	57,720
MPA	per 1 credit	24,330	20,280	17,190	14,950
	3 credits/ 1 course	72,990	60,840	51,570	44,850
MIR	per 1 credit	24,330	20,280	17,190	14,950
	3 credits/ 1 course	72,990	60,840	51,570	44,850
MAIJ	per 1 credit	23,000	19,170	16,250	14,130
	3 credits/ 1 course	69,000	57,510	48,750	42,390
MA in TESOL	per 1 credit	23,000	19,170	-	-
	3 credits/ 1 course	69,000	57,510	-	-
LLM	per 1 credit	32,800	-	-	-
	3 credits/ 1 course	98,403	-	-	-
Non-CIS foreign countries, Graduate		2008-09	2007-08	2006-07	2005-06
DBA	per 1 credit	131,440	109,540	109,545	-
	3 credits/ 1 course	394,320	328,620	328,635	-
MBA	per 1 credit	49,330	41,110	34,840	30,300
	3 credits/ 1 course	147,990	123,330	104,520	90,900
MA	per 1 credit	46,890	39,080	33,120	28,800
	3 credits/ 1 course	140,670	117,240	99,360	86,400
MPA	per 1 credit	36,620	30,520	25,870	22,500
	3 credits/ 1 course	109,860	91,560	77,610	67,500
MIR	per 1 credit	36,620	30,520	25,870	22,500
	3 credits/ 1 course	109,860	91,560	77,610	67,500
MAIJ	per 1 credit	34,660	28,890	24,490	21,300
	3 credits/ 1 course	103,980	86,670	73,470	63,900
MA in TESOL	per 1 credit	34,660	28,890	-	-
	3 credits/ 1 course	103,980	86,670	-	-
LLM	per 1 credit	49,330	-	-	-
	3 credits/ 1 course	147,990	-	-	-
Kazakhstan & CIS, Undergraduate		2008-09	2007-08	2006-07	2005-06
BSc	per 1 credit	22,650	18,880	16,000	13,910
	3 credits/1 course	67,950	56,640	48,000	41,730
BSS	per 1 credit	20,950	17,460	14,800	12,870
	3 credits/ 1 course	62,850	52,380	44,400	38,610
BAE	per 1 credit	20,950	17,460	14,800	12,870
	3 credits/ 1 course	62,850	52,380	44,400	38,610
BAIJ	per 1 credit	16,600	13,840	11,730	10,200
	3 credits/ 1 course	49,800	41,520	35,190	30,600
Non-CIS Foreign Countries, Undergraduate		2008-09	2007-08	2006-07	2005-06
BSc	per 1 credit	34,180	28,490	24,150	21,000
	3 credits/ 1 course	102,540	85,470	72,450	63,000
BSS	per 1 credit	31,740	26,450	22,420	19,500
	3 credits/ 1 course	95,220	79,350	67,260	58,500
BAE	per 1 credit	31,740	26,450	22,420	19,500
	3 credits/ 1 course	95,220	79,350	67,260	58,500
BAIJ	per credit	24,900	20,750	17,590	15,300
	3 credits/ 1 course	74,700	62,250	52,770	45,900

\* Information was taken from KIMEP Catalog 2008-2009

**FEES, KZT**

## Some Other Fees, KZT

	2008-09	2007-08	2006-07	2005-06
English for Level	81,140	70,560	52,000	52,000
Introduction to Computers, <i>Test</i>	2,030	1,770	1,500	1,300
Introduction to Computers, <i>Course</i>	20,280	17,640	14,950	13,000
Pre-MA courses ( <i>per course</i> )	40,250	35,000	29,900	26,000
Pre-MBA courses ( <i>per course</i> )	40,250	35,000	29,900	26,000

Student Dormitory Fees, *per month*, KZT

	2008-09 <i>all with telephones</i>	2007-08 <i>all with telephones</i>	2006-07	2005-06
Bed in double room without telephone	-	-	-	6,501
Bed in double room with telephone	-	-	-	7,151
Bed in deluxe double room	11,442	10,402	-	10,402
Bed in room with telephone ( <i>3-4 floors</i> )	9,273	8,430	7,151	-
Bed in deluxe room with telephone	-	13,020	10,402	-
Bed in renovated room with telephone ( <i>fifth floor</i> )	12,650	11,500	9,750	-
Bed in triple room	-	-	-	4,941
Bed in deluxe triple room with telephone	-	-	9,101	9,101
Bed in deluxe room ( <i>fifth floor</i> )	14,322	-	-	-
Bed in renovated room with telephone ( <i>second floor</i> )	10,450	-	-	-
Bed in deluxe room ( <i>second floor</i> )	12,650	-	-	-

## Services Fees, KZT

	2008-09	2007-08
Student activities fee (per year)	cancelled	4 000
Late payment fee	8 820	7 670
Late registration fee (per course)	4 470	3 890
Late monthly payment interest	cancelled	1 300
Official transcript (3 copies)	1 750	1 530
Withdrawal administrative fee	4 470	3 890
Student Card	80	80
Replacement of Student Card	1 300	1 300
Library Card Replacement	1 500 (laminated) 3 000 (plastic card)	1 500
Textbook security deposit (fixed)	15 000	15 000
Textbook rental fee (withdrawn from deposit)	25% of replacement cost of item	25% of replacement cost of item
Duplicate and replacement of Diploma	1 750	1 530
Graduation ceremony fee (fixed)	2 030	1 500



## CAMPUS AND FACILITIES\*

### Library Holdings and Space, 2005-08

	2007-08	2006-07	2005-06
<b>BOOKS, TOTAL</b>	<b>90 118</b>	<b>85 935**</b>	<b>228 481</b>
<b>Collection in Use</b>			
<i>English</i>	55 509	51 752	44 456
<i>Russian</i>	4 937	4 599	4 345
<i>Kazakh</i>	792	705	680
<b>Old Collection</b>			
<i>Russian</i>	20 000	20 000	158 000
<i>Kazakh</i>	8 880	8 880	21 000
<b>E-RESOURCES, TOTAL</b>	<b>9</b>	<b>9</b>	<b>7</b>
<i>EBSCO</i>	✓	✓	✓
<i>INTAS</i>	✓	✓	✓
<i>JURIST</i>	✓	✓	✓
<i>KIMEP Reference Database</i>	✓	✓	✓
<i>JSTOR</i>	✓	✓	✓
<i>SSRN</i>	✓	✓	✓
<i>EconLit</i>	-	✓	-
<i>Ebrary</i>	✓	✓	✓
<i>ABI/INFORM Global</i>	✓	✓	-
<i>EVIEW'S</i>	✓	-	-
<b>PERIODICALS, TOTAL</b>	<b>190</b>	<b>170</b>	<b>115</b>
<i>Scholarly journals</i>	56	53	32
<i>Other periodicals</i>	164	117	83
<b>FACILITIES</b>			
<b>SPACE, m<sup>2</sup></b>	<b>3 388</b>	<b>3 388</b>	<b>1 600</b>
<b>SEATS</b>	<b>455</b>	<b>450</b>	<b>275</b>
<b>COMPUTERS</b>	<b>71</b>	<b>68</b>	<b>11</b>

\*\* Number of out-dated books from old collection were donated and/or sold.

### Computer Facilities, 2005-09

	2008-09	2007-08	2006-07	2005-06
<b>STUDENT COMPUTER FACILITIES</b>				
Computer Laboratories	18	14	14	13
Student Computer Areas	4	4	3	-
Computers in the Laboratories and Areas ( <i>all connected to LAN and Internet</i> )	492	385	359	287
Students per Computer Ratio	10	12,7	12	12
<b>ALL COMPUTER FACILITIES</b>				
Computers on Campus	1300	1112	990	798
Computers connected to LAN	1300	1112	890	696
Computers connected to Internet	1251	1063	850	603
<b>INTERNET SPEED</b>				
Internet Access Speed	7.5Mbps	7.5Mbps	4.5Mbps	2.5Mbps

\* Data was provided by Library and Computer and Information Systems Center.

## Dynamics of KIMEP Computer Facilities, 2005-09

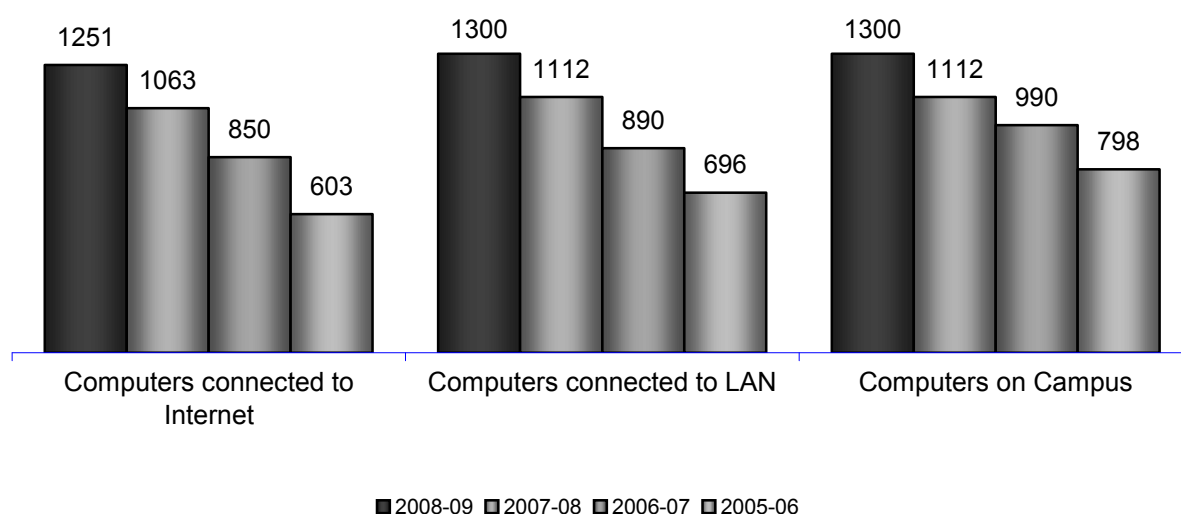

## KIMEP Teaching Aid Facilities

*As of Spring 2008*

<b>Projectors</b>		<b>Recorders</b>	
Overhead Projectors	40	Audio Recorders	60
LCD Projectors	52	Video Cameras	1
Video Projectors	2	Video Recorders	10
<b>Players</b>		<b>Acoustics</b>	
TV sets	13	Radio Microphones	54
DVD Player	7	Speaker Systems	40
Mini Disc Player	2	Sound Buffers	5
Automatic Telephone Stations	4	Acoustic Systems	40
<b>Illumination</b>		Sound Processor	1
Dimmer blocks	2	Mixer board	2
Illumination Projectors	20	Microphones	12

## Campus Technical Characteristics

	Fall 2008	Spring 2008	Spring 2007
Total proprietary space of buildings (in square meters)	42,652 m <sup>2</sup>	36,075.6 m <sup>2</sup>	18,337.85 m <sup>2</sup>
Instructional and laboratory proprietary space of buildings (in square meters)	9,929 m <sup>2</sup>	6,260 m <sup>2</sup>	15,231 m <sup>2</sup>
Proprietary space of dormitories (in square meters)	7,075 m <sup>2</sup>	7,075 m <sup>2</sup>	7,075 m <sup>2</sup>
Proprietary space of dining services (in square meters)	1,629.95 m <sup>2</sup>	1,147.75 m <sup>2</sup>	1,325.45 m <sup>2</sup>
Proprietary space of gyms and other covered sport facilities (in square meters)	1,444.4 m <sup>2</sup>	728.8 m <sup>2</sup>	1,781.4 m <sup>2</sup>



## UNIVERSITY FINANCES\*

### KIMEP Budget 2007-08, USD

DESCRIPTION	2007-2008
Academic revenue	20,660,500
Other academic revenues	804,500
Intensive courses	592,000
Tuition waiver for KIMEP employees	(129,000)
Restricted Grants and Scholarships	400,000
Unrestricted Fundraising - Scholarships/operations	220,000
Commercial programs	904,500
Non-degree students	303,500
Other Revenues	722,000
<b>TOTAL REVENUE</b>	<b>24,478,000</b>
<b>Payroll fund</b>	<b>13,082,000</b>
<b>Other Direct Expenses</b>	<b>1,944,000</b>
Stationary/Copying	364,500
Public Utilities	376,500
Telecommunications/Subscriptions	409,500
Mail/Courier	10,000
Repair and Maintenance Expenses	223,000
Other Department's Expenses	560,500
<b>Indirect Expenses</b>	<b>2,948,500</b>
Medical insurance	220,500
Marketing	471,500
15th Anniversary	233,000
Graduation / BOT	153,000
Recruitment	168,000
Financial	76,500
Taxes (excl. CIT)	290,000
Research	160,000
Custodial	68,500
Audit, Legal and Other	105,000
KIMEP Scholarships	1,002,500
<b>Other Unbudgeted Items</b>	<b>180,000</b>
<b>TOTAL OPERATING EXPENSES</b>	<b>18,154,500</b>
Computer related	201,500
Furniture	94,000
Books, Periodicals, etc.	377,000
Equipment	209,000
Vehicles	25,000
Other Projects:	685,000
Valikhanov building (ventilation)	80,000
Student Center - Fast Food	132,000
Faculty Offices and Furniture / Equipment	130,000
Sport Center	180,000
Other	171,000
<b>TOTAL General Capital Expenses (GCE)</b>	<b>1,591,500</b>
<b>NET RESULT AFTER GCE</b>	<b>4,732,001</b>
Endowment (Operating Reserve, 5% beginning 2008-09)	400,000
Major Capital Expenditures - New Academic Building	2,900,000
New Academic Building - Furnishing, estimated final payment)	830,000
Electricity for new building	1,430,000
Gas Powered Generator	187,000
<b>NET SURPLUS / DEFICIT</b>	<b>(1,015,000)</b>

\* Data was provided by Finance and Planning Department

KIMEP Budget, 2005-08, *mln. USD*

Academic Year	Total revenue	Total operating expenses	Total capital expenditures	Fund raising activity	Net result
2007-08	24.5	18.2	7.3	0.2	-0.1
2006-07	18.9	14.5	4.4	0.7	0
2005-06	14.1	10.1	4.2	0.4	-0.2

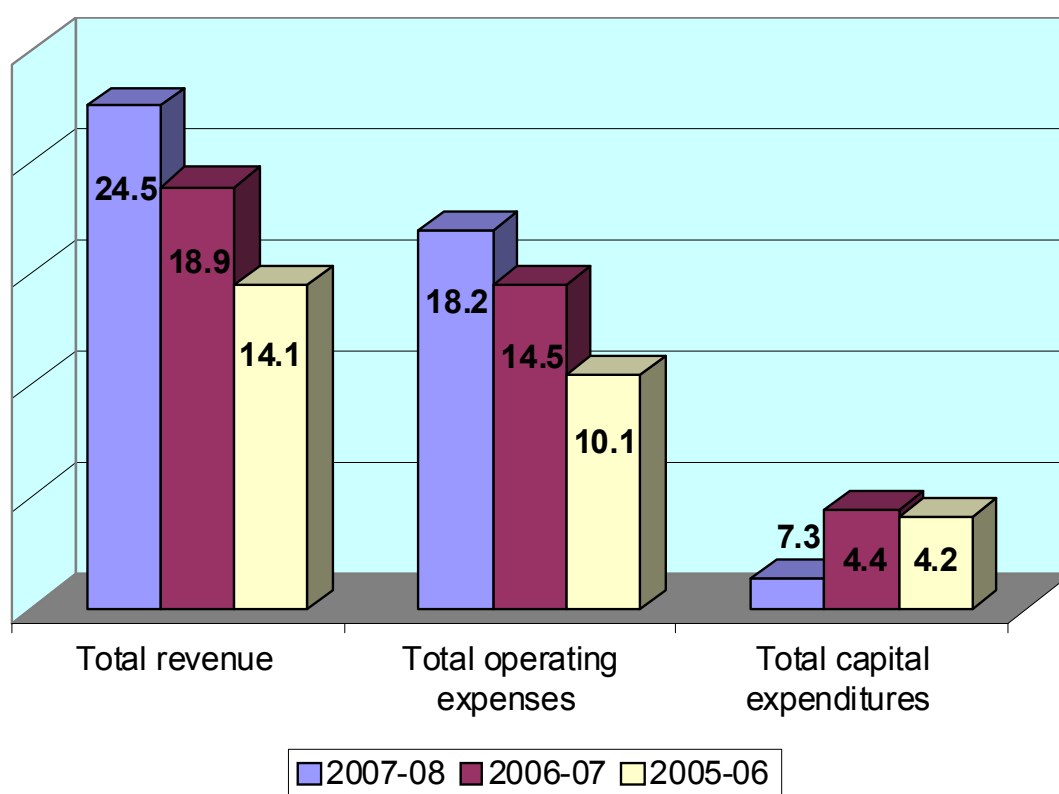
KIMEP Budget Dynamics, 2005-08, *mln. USD*



## ADMINISTRATIVE STAFF\*

### NUMBER AND SCOPE

#### Staff Headcount, as of Fall 2007\*\*

	MANAGEMENT	SUBORDINATES	TOTAL
<b>President's Office, Subtotal</b>	<b>10</b>	<b>15</b>	<b>25</b>
Office of the President	3	6	9
Office of the Executive Vice-President	2	1	3
Department of Quality Assurance and Institutional Research	2	6	8
Kazakhstan Development Center	2	2	4
Joint-Stock Company Affairs	1	0	1
<b>Academic Affairs, Subtotal</b>	<b>44</b>	<b>108</b>	<b>152</b>
Office of the Vice-President of Academic Affairs	2	3	5
Library	2	36	38
Office of the Registrar	4	10	14
Bang College of Business	10	12	22
College of Continuing Education	8	11	19
College of Social Sciences	8	10	18
Language Center	5	9	14
International Relations	1	2	3
Recruitment and Admissions	3	10	13
Student Financial Services Sector	1	5	6
<b>Advancement, Subtotal</b>	<b>4</b>	<b>7</b>	<b>11</b>
Corporate Development Department	2	3	5
Career and Employment Center	1	1	2
Marketing and Public Relations Department	1	3	4
<b>Administration and Finance, Subtotal</b>	<b>27</b>	<b>286</b>	<b>313</b>
Office of the Vice-President of Administration and Finance	2	3	5
Legal Office	2	2	4
Translation/Interpretation Department	1	2	3
Human Resources Department	2	8	10
Finance and Accounting Department	6	17	23
Computer and Information Systems Center	2	54	56
Office of the Director of Support Services Division	1	7	8
Internal Security Department	3	43	46
Publishing Department	1	8	9
Plant Department	2	42	44
Engineering Department	1	12	13
Building Management Department	1	81	82
Department of Technical Facilities for Educational Purposes	1	4	5
Procurement Department	1	2	3
Off-Campus Housing Department	1	1	2
<b>Student Affairs, Subtotal</b>	<b>7</b>	<b>16</b>	<b>23</b>
Office of the Dean of Student Affairs	2	2	4
Student Affairs Department	3	1	4
Medical Center	1	9	10
Dormitory	1	4	5
<b>GRAND TOTAL</b>	<b>92</b>	<b>432</b>	<b>524</b>

\*\*Data is based on Staff Hiring Plan, provided by HR Department

\* Data for Fall 2008 will be prepared by HR Department in October, 2008

## PROFESSIONAL DEVELOPMENT

### Support Staff Studying Abroad, 2007-08

Position/Unit	Degree to Obtain	Field of Study	Country
Specialist/Admission and Information Center	Master	Economics in Education	USA
Coordinator/CCE	Master	Accounting	Australia
Executive Assistant/Office of Academic Affairs	Master	Public Administration	USA
Manager/Library	Master	Library and IS	USA
Director/Korean Center	Doctorate	Korean Studies	South Korea

### Support Staff Studying at KIMEP, 2005-08

Year	Program	Unit	Number of employees
2007-08	MAIJ	Enrollment Management	1
	MBA	Academic Affairs	2
	MBA	Enrollment Management	1
	MBA	Student Affairs	1
	<b>Subtotal</b>		<b>5</b>
2006-07	DBA	Division of Administration and Finance	2
	MA	Support Services Division	1
	MATESOL	BCB	1
	MATESOL	Enrollment Management	1
	MATESOL	LC	3
	MBA	BCB	1
	MBA	CCE	1
	MBA	Division of Advancement	1
	MBA	Enrollment Management	1
	MBA	Office of the President	1
	MBA	Office of the Executive Vice-President	1
	MBA	Quality Assurance & Institutional Research	1
	MBA	Student Affairs	1
	MBA	The Registrar	3
	MPA	CSS	1
	MPA	Student Affairs	2
<b>Subtotal</b>		<b>22</b>	
2005-06	DBA	Division of External Affairs	1
	MAIJ	CSS	1
	MBA	Academic Affairs	1
	MBA	Admission and Information Center	1
	MBA	BCB	2
	MBA	CCE	1
	MBA	CISC	3
	MBA	Division of Administration and Finance	2
	MBA	LC	2
	MBA	Library	2
	MBA	Medical Center	1
	MBA	Office of the President	1
	MBA	Student Affairs	3
	MBA	Support Services Division	2
MPA	CSS	1	
<b>Subtotal</b>		<b>24</b>	

### Staff Participation in Professional Trainings at College of Continuing Education, 2006-08

Program	SU2008	S2008	F2007	SU2007	S2007	F2006	SU2006	S2006
Open Enrollment and Certificate Programs	3	5	6	16	18	28	22	40
Professional Development Programs	50	2	34	33	50	100	10	32
American Management Association Program	8	18	23	13	43	41	15	59
<b>TOTAL</b>	<b>61</b>	<b>25</b>	<b>63</b>	<b>62</b>	<b>111</b>	<b>169</b>	<b>47</b>	<b>131</b>



# Key Contact Details

## PRESIDENT

### President's Office

*Chan Young Bang, Ph.D., **President of KIMEP***  
[bang@kimep.kz](mailto:bang@kimep.kz), +7 (727) 270-42-00 (# 2005)  
 050010 Kazakhstan, Almaty, Abai Ave 2, Room # 102, Dostyk building

*Ewan Simpson, Ph.D., **Executive Director of the President's Office***  
[simpson@kimep.kz](mailto:simpson@kimep.kz), +7 (727) 270-44-85 (# 2001)  
 050010 Kazakhstan, Almaty, Abai Ave 2, Room # 104, Dostyk building

### Executive Vice President's Office

*Habib Rahman, Ph.D., **Executive Vice President***  
[rahman@kimep.kz](mailto:rahman@kimep.kz), +7 (727) 270-42-05 (# 2008)  
 050010 Kazakhstan, Almaty, Abai Ave 2, Room # 105, Dostyk building

*Rassim Karibov, MBA, **Director of the Executive Vice President's Office***  
[karibov@kimep.kz](mailto:karibov@kimep.kz), +7 (727) 270-42-03 (# 2105)  
 050010 Kazakhstan, Almaty, Abai Ave 2, Room # 115, Dostyk building

### Consultancy for Central Asia

*Charles Armitage, Ph.D., **Director***  
[charles@kimep.kz](mailto:charles@kimep.kz) +7 (727) 237-47- 80 (#1081)  
 050010 Kazakhstan, Almaty, Abai Ave 4, Room # 111, Valikhanov building

### Governance, Foundation and Joint-Stock Company Affairs

*Olga Uzhegova , MBA, **Director of Development***  
[boss@kimep.kz](mailto:boss@kimep.kz) +7 (727) 270-42-06 (#2016)  
 050010 Kazakhstan, Almaty, Abai Ave 2, Room # 110, Dostyk building

### Institutional Research, Strategic Planning and Quality Assurance Department

*Mansiya Kainazarova, Candidate of Sciences, **Deputy Director***  
[mansiya@kimep.kz](mailto:mansiya@kimep.kz), +7 (727) 270-42-53 (#3486)  
 050010 Kazakhstan, Almaty, Abai Ave 4, Room # 406, Valikhanov building

### Legal Office

*Azamat Murzagaliyev, BA, **Deputy Chief Legal Counsel***  
[azamat@kimep.kz](mailto:azamat@kimep.kz) +7 (727) 270-44-74 (#2007)  
 050010 Kazakhstan, Almaty, Abai Ave 2, Room # 408, Dostyk building

## ACADEMIC AFFAIRS

### Office of the Vice President of Academic Affairs

*Dana Stevens, Ph.D., **Acting Vice President of Academic Affairs***  
[stevens@kimep.kz](mailto:stevens@kimep.kz), + 7 (727) 270-44-67 (# 2139),  
 050010 Kazakhstan, Almaty, Abai Ave 2, Room # 103, Dostyk building

*John Knarr, Ph.D., **Acting Associate Vice President of Academic Affairs***  
[jknarr@kimep.kz](mailto:jknarr@kimep.kz) +7 (727) 270-44-95 (# 2256),  
 050010 Kazakhstan, Almaty, Abai Ave 2, Room # 103, Dostyk building

## Bang College of Business

050010 Kazakhstan, Almaty, Abai Ave 2, Dostyk building

Dean's Office	<i>Sang Hoon Lee, Ph.D., <b>Dean of Bang College of Business</b></i> <i><a href="mailto:shlee@kimep.kz">shlee@kimep.kz</a>, + 7 (727) 270-44-66 (#2255), Room # 302</i>
	<i>Mujibul Haque, Ph.D., <b>Associate Dean</b></i> <i><a href="mailto:mmhaque@kimep.kz">mmhaque@kimep.kz</a>, + 7 (727) 270-43-63 (#2138), Room # 302</i>
Department of Accounting	<i>Robert Kevlihan, MA, <b>Acting Chair</b></i> <i><a href="mailto:rkevlihan@kimep.kz">rkevlihan@kimep.kz</a>, + 7 (727) 270-43-56 (#2245), Room # 311</i>
Department of Finance	<i>Simon Tai, Ph.D., <b>Chair</b></i> <i><a href="mailto:tai@kimep.kz">tai@kimep.kz</a>, +7 (727) 270-43-61 (#2257), Room # 328</i>
Department of Management and Marketing	<i>Dilbar Gimranova, MBA, M.Phil., <b>Chair</b></i> <i><a href="mailto:dilbar@kimep.kz">dilbar@kimep.kz</a>, + 7 (727) 270-44-40 (#2076), Room # 329</i>
Department of Operations Management and Information Systems	<i>Swapan Kumar Majumdar, Ph.D., <b>Chair</b></i> <i><a href="mailto:majumdar@kimep.kz">majumdar@kimep.kz</a>, + 7 (727) 270-44-86, 270-44-40 (#2142), Room # 334</i>

## College of Social Sciences

050010 Kazakhstan, Almaty, Abai Ave 4, Valikhanov building

Dean's Office	<i>Hal Foster, Ph.D., <b>Acting Dean of College of Social Sciences</b></i> <i><a href="mailto:foster@kimep.kz">foster@kimep.kz</a>, + 7 (727) 270-42-46 (# 3007), Hall # 4</i>
Department of Economics	<i>Islam Abu, Ph.D., <b>Chair</b></i> <i><a href="mailto:abuislam@kimep.kz">abuislam@kimep.kz</a>, +7 (727) 270 42 72 (# 3059), Room # 220</i>
Department of Journalism and Mass Communications	<i>Brian P. Farley, Ph.D., <b>Chair</b></i> <i><a href="mailto:bpfarley@kimep.kz">bpfarley@kimep.kz</a>, +7 (727) 270-42-95 (#3109), Room # 416</i>
Department of Political Science	<i>Mostafa Golam, Ph.D., <b>Chair</b></i> <i><a href="mailto:gmostafa@kimep.kz">gmostafa@kimep.kz</a>, + 7 (727) 270-42-50 (#3062), Room # 108</i>
Department of Public Administration	<i>Aigerim Ibrayeva, M.Phil., <b>Chair</b></i> <i><a href="mailto:aibr@kimep.kz">aibr@kimep.kz</a>, + 7 (727) 270-42-66 (#3125), Room # 306</i>

## College of Continuing Education

050010 Kazakhstan, Almaty, Abai Ave 4, Executive Education Center

Dean's Office	<i>Albert Lang, MBA, <b>Dean of College of Continuing Education</b></i> <i><a href="mailto:albert@kimep.kz">albert@kimep.kz</a>, + 7 (727) 270-44-32, (#1173), Room # 102</i> <i>Alma Raissova, Candidate of Sciences, <b>Associate Dean</b></i> <i><a href="mailto:raissova@kimep.kz">raissova@kimep.kz</a>, + 7 (727) 237-47-89, (#1084), Room # 105</i>
Open Enrollment and Certificate Programs	<i>Akhmetova Sharzada, Candidate of Sciences, <b>Deputy Director</b></i> <i><a href="mailto:sharzada@kimep.kz">sharzada@kimep.kz</a>, + 7 (727) 237-47-82, (#1154), Room # 107</i>
Pre - Degree Programs	<i>Tundikbayeva Bakhytgul, Diploma, <b>Manager</b></i> <i><a href="mailto:tpk@kimep.kz">tpk@kimep.kz</a>, + 7 (727) 237-47-76, (#1001), Room # 113</i>
Professional Development Programs	<i>Raushan Zhaparova, MA, <b>Director</b></i> <i><a href="mailto:razh@kimep.kz">razh@kimep.kz</a>, + 7 (727) 270-44-15, (#1122), Room # 101</i>

## General Education Department

050010 Kazakhstan, Almaty, Abai Ave 4, Valikhanov building

### Dean's Office

Kathy Parkison, Ph.D., **Director**

[parkison@kimep.kz](mailto:parkison@kimep.kz), + 7 (727) 270-42-43 (#3245), Room # 505

## Language Center

050010 Kazakhstan, Almaty, Abai Ave 2, Dostyk building

### Office of Director

Kenneth Saycell, MA, **Director**

[ksaycell@kimep.kz](mailto:ksaycell@kimep.kz), + 7 (727) 270-43-71 (#2264), Room # 228

## School of Law

050010 Kazakhstan, Almaty, Abai Ave 4, New Academic building

### Office of Director

John Wright, JUDr, LL.M, **Director**

[jwright@kimep.kz](mailto:jwright@kimep.kz), + 7 (727) 237-47-57 (#2726), Room # 119

## Korean Studies Center

050010 Kazakhstan, Almaty, Abai Ave 2, Dostyk building

### Office of Director

Cho, Myung Rae, Ph.D., **Acting Director**

[mrcbo55@kimep.kz](mailto:mrcbo55@kimep.kz), + 7 (727) 270-43-89 (#2181), Room # 222

## Library

050010 Kazakhstan, Almaty, Abai Ave 2, Library building

### Office of Library Director

Luke Joseph, MLIS, MA, **Director**

[libinstr@kimep.kz](mailto:libinstr@kimep.kz), + 7 (727) 237-47-53 (#2504), Room # 109

## International Relations

050010 Kazakhstan, Almaty, Abai Ave 2, Dostyk building

### International Relations

Ronald Voogdt, **Director**

[rvoogdt@kimep.kz](mailto:rvoogdt@kimep.kz), + 7 (727) 270-43-80 (#2258), Room # 411

## ADVANCEMENT

### Office of the Vice- President of Advancement

Kadisha Dairova, Candidate of Sciences, **Vice President of Advancement**

[dairova@kimep.kz](mailto:dairova@kimep.kz), + 7 (727) 270-43-65 (#2190), Room # 407  
050010 Kazakhstan, Almaty, Abai Ave 2, Dostyk building

### Alumni Center

Victoria Tazhmagambetova, **Coordinator**

[alumni@kimep.kz](mailto:alumni@kimep.kz), + 7 (727) 270-42-26 (#2166)  
050010 Kazakhstan, Almaty, Abai Ave 2, Room # 412, Dostyk building

### Career and Employment Center

Mernert Adaibekova, MBA, **Director**

[plof@kimep.kz](mailto:plof@kimep.kz), + 7 (727) 270-42-15, 270-42-16 (#2090)  
050010 Kazakhstan, Almaty, Abai Ave 2, Room # 412, Dostyk building

### Corporate Department

### Development

Balzhhan Suzhikova, Candidate of Sciences, **Director**

[bsuzhikova@kimep.kz](mailto:bsuzhikova@kimep.kz), + 7 (727) 270-42-26 (#2044)  
050010 Kazakhstan, Almaty, Abai Ave 2, Room # 401, Dostyk building

Department of Marketing and Public Relations *Beissova Ainagul, MBA, Director*  
*marketing@kimep.kz, + 7 (727) 270-42-21 (#2032)*  
*050010 Kazakhstan, Almaty, Abai Ave 2, Room # 404a, Dostyk building*

## OFFICE OF ENROLLMENT MANAGEMENT

Dean's Office *Larissa Savitskaya, M.Ed., MPA, Dean of Enrollment Management*  
*larissa@kimep.kz +7(727) 270-43-18 (#3141)*  
*050010 Kazakhstan, Almaty, Abai Ave 4, Registration and Admission Office*

Office of the Registrar *Uvasilya Tanekenova, MBA, Acting Registrar*  
*database@kimep.kz +7 (727) 237-47-95, 270-44-71 (#1038)*  
*050010 Kazakhstan, Almaty, Abai Ave 4, Registration Office*

Office of Senior Director of Recruitment and Admission *Meruert Duisengaliyeva, MBA, Senior Director*  
*mira@kimep.kz, + 7 (727) 270-43-34 (#3158)*  
*050010 Kazakhstan, Almaty, Abai Ave 4, Registration and Admission Office*

Student Financial Services Department *Shegay Oxana, MBA, Director*  
*raxaus@kimep.kz, + 7 (727) 270-42-17 (#3329)*  
*050010 Kazakhstan, Almaty, Abai Ave 4, Financial Services Office*

## STUDENT AFFAIRS

Office of the Dean of Student Affairs *Jonathan Pixler, MA, Dean of Student Affairs*  
*jonathan@kimep.kz, + 7 (727) 270-42-08 (#2003),*  
*050010 Kazakhstan, Almaty, Abai Ave 2, Room # 109, Dostyk building*

Office of the Senior Director of Student Affairs *Yevgeniya Kim, MA, Senior Director*  
*yevgeniya@kimep.kz, + 7 (727) 270-42-07 (#2011),*  
*050010 Kazakhstan, Almaty, Abai Ave 2, Room # 107, Dostyk building*

Medical Center *Gulshara Moldakhmetova, MBA, Director*  
*gulshara@kimep.kz, + 7 (727) 270-43-17 (#1325)*  
*050010 Kazakhstan, Almaty, Abai Ave 2, Dormitory building*

Sports Center *Yergazy Orazaliyev, Diploma, Director*  
*erik@kimep.kz +7 (727) 270-44-42 (#2187),*  
*050010 Kazakhstan, Almaty, Abai Ave 2, Sports Center*

Student Center *Sholpan Sugurbekova, MPA, Director*  
*sholpans@kimep.kz +7 (727) 270-44-44 (#2315),*  
*050010 Kazakhstan, Almaty, Abai Ave 2, Student Center*

Student Dormitory *Zulfiyat Almukhanova, Diploma, Director*  
*zulfiyat@kimep.kz +7(727) 237-47-71 (#1246),*  
*050010 Kazakhstan, Almaty, Abai Ave 2, Dormitory building*

## ADMINISTRATION AND FINANCE

Vice President of Administration and Finance Office	<p><i>James M. Wood, MA, CPA, Vice President of Administration and Finance</i>  <a href="mailto:jwood@kimep.kz">jwood@kimep.kz</a>, + 7 (727) 270-42-25 (#2043)          050010 Kazakhstan, Almaty, Abai Ave 2, Room # 114, Dostyk building</p>
	<p><i>Sergei Katsovich, MBA, Assistant Vice President of IT and HR</i>  <a href="mailto:sergei@kimep.kz">sergei@kimep.kz</a>, + 7 (727) 270-42-02 (#2017)          050010 Kazakhstan, Almaty, Abai Ave 2, Room # 112, Dostyk building</p>
Computer and Information Systems Center	<p><i>Galina Stepanova, Diploma, Director</i>  <a href="mailto:gast@kimep.kz">gast@kimep.kz</a>, + 7 (727) 270-42-91 (#3102)          050010 Kazakhstan, Almaty, Abai Ave 4, Room # 333, Valikhanov building</p>
Department of Finance and Accounting	<p><i>Altynai Saparova, MBA, Director of Finance and Controller</i>  <a href="mailto:cfo@kimep.kz">cfo@kimep.kz</a>, <a href="mailto:finance@kimep.kz">finance@kimep.kz</a>, + 7 (727) 270-42-22 (#2039)          050010 Kazakhstan, Almaty, Abai Ave 2, Room # 119, Dostyk building</p> <p><i>Elena Danilova, MBA, Chief Accountant</i>  <a href="mailto:accountk@kimep.kz">accountk@kimep.kz</a>, + 7 (727) 270-42-24 (#2037)          050010 Kazakhstan, Almaty, Abai Ave 2, Room# 117, Dostyk building</p> <p><i>Daniyar Zhamenov, Diploma, Director of Budget Department</i>  <a href="mailto:zhamenov@kimep.kz">zhamenov@kimep.kz</a>, + 7 (727) 270-44-10 (#2039)          050010 Kazakhstan, Almaty, Abai Ave 4, Room # 121, Dostyk building</p>
Human Resource Department	<p><i>Irina Demijanova, Diploma, Senior Personnel Officer</i>  <a href="mailto:irinad@kimep.kz">irinad@kimep.kz</a>, + 7 (727) 270-42-10 (#2014)          050010 Kazakhstan, Almaty, Abai Ave 2, Room # 113, Dostyk building</p>
Support Services Division	<p><i>Nurlan Bolysbekov, MA, Director of Support Services</i>  <a href="mailto:nbolysbekov@kimep.kz">nbolysbekov@kimep.kz</a>, + 7 (727) 237-47-55 (#2555)          050010 Kazakhstan, Almaty, Abai Ave , Plant</p>
Translation/Interpretation Department	<p><i>Adil Valikhanov, Diploma, Director</i>  <a href="mailto:adil@kimep.kz">adil@kimep.kz</a>, + 7 (727) 270-44-45 (#2305)          050010 Kazakhstan, Almaty, Abai Ave 2, Room # 301, Dostyk building</p>